

## **Internal Audit 3.0**

The future of Internal Audit is now

April 2018

# Contents

|                             |    |
|-----------------------------|----|
| Internal Audit 3.0          | 01 |
| Assure. Advise. Anticipate. | 04 |
| Assure                      | 07 |
| Advise                      | 10 |
| Anticipate                  | 13 |
| Contacts                    | 15 |

# Internal Audit 3.0

The future of Internal Audit is now

As organizations hurtle into an increasingly technology-driven, innovation-oriented, risky, and disruptive future, where is Internal Audit? Very often, despite ongoing efforts to meet stakeholders' growing list of needs, the answer is: playing catch-up.

What's often missing is the realization that organizations and the business environment have changed in material ways, which demand innovation. Without applying new approaches, an Internal Audit function is rendered behind strategic and technological developments, unable to meet stakeholder needs, and ill-equipped to deal with emerging risks. By the same token, embracing innovative approaches helps keep the function ahead of developments. Innovation positions Internal Audit to anticipate and then respond effectively to stakeholder needs, and equips the internal auditors, themselves, to address emerging risks in a helpful and impactful manner.

We have long been encouraging Internal Audit to adopt new tools and techniques and to develop capabilities needed to effectively respond to today's challenges. It is equally important for Internal Audit to develop a coherent vision for both the profession and the function. Such a vision is essential in order to drive needed changes and prioritize initiatives for the function and the organization as a whole.

Through consultation with audit committee chairs, executives, chief audit executives and business leaders, we have developed a blueprint which aims to clarify the expectations of Internal Audit, codifying the most important components.

We call it Internal Audit 3.0, the next generation of Internal Audit, a function as attuned to the challenges of emerging risks, technologies, innovation, and disruption as the organization itself; a function fully able to assist in safeguarding processes and assets as management pursues new methods of creating and delivering value.

As with any useful new release of an operating system or application, Internal Audit 3.0 updates that which needs updating, offers new features and functionality, and retains and leverages the best of past versions. Internal Audit 3.0 may therefore be considered an innovative "operating system" that enables the Internal Audit profession and function to better meet both existing and emerging needs.

## Where we've been

Until recently, the Internal Audit profession has not faced the need to innovate, let alone reinvent itself. We can trace the birth of modern Internal Auditing – "Internal Audit 1.0" – to the founding of the Institute of Internal Auditors (IIA) in 1941 – and trace "Internal Audit 2.0" to Sarbanes Oxley and its impact on the accounting profession (Figure 1). Along the way, developments such as the COSO framework, improved capabilities such as IT internal audit and data analytics, and supplementary guidance to improve the profession following the global financial crisis helped move the profession forward.

Figure 1. Key Internal Audit milestones

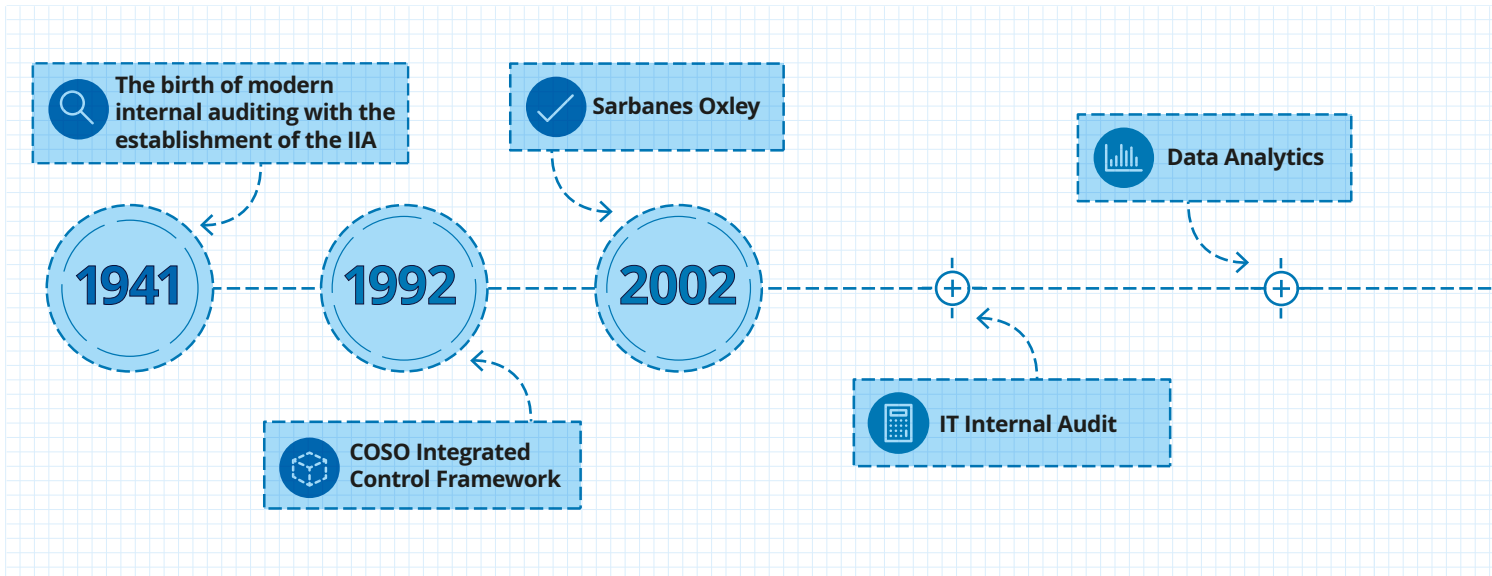

Now, however, as we approach the end of a decade of unsettling uncertainty, organizations face evolving strategic, reputational, operational, financial, regulatory, and cyber risks. And there is a need to constantly innovate in order to compete (Figure 2). The world is entering the fourth industrial revolution where new technologies, digitalization, and artificial intelligence are dramatically changing the business landscape.

The types, complexities, and inter-dependencies of risks associated with the fourth industrial revolution, and the speed at which they emerge are new. The pressures to evolve in order to create and deliver value are new. The strategies, practices, and technologies that organizations employ are new. All of which are compelling Internal Audit to adopt a new vision of its role and remit, to maintain its relevance in providing impactful assurance and advisory services to organizations.

Failure to act will allow the risks that the organization faces to outpace Internal Audit's skills and capabilities. On the flip side, however, taking action will position Internal Audit to create and deliver new value to its stakeholders, just as the organization strives to do so for its constituents.

Although Internal Audit's service emphasis and delivery models must be updated, its central purpose remains much the same: to assure and advise. However, in our view, the most successful Internal Audit functions will also anticipate, and through proactive assurance, help organizations keep pace with and get ahead of emerging risks.

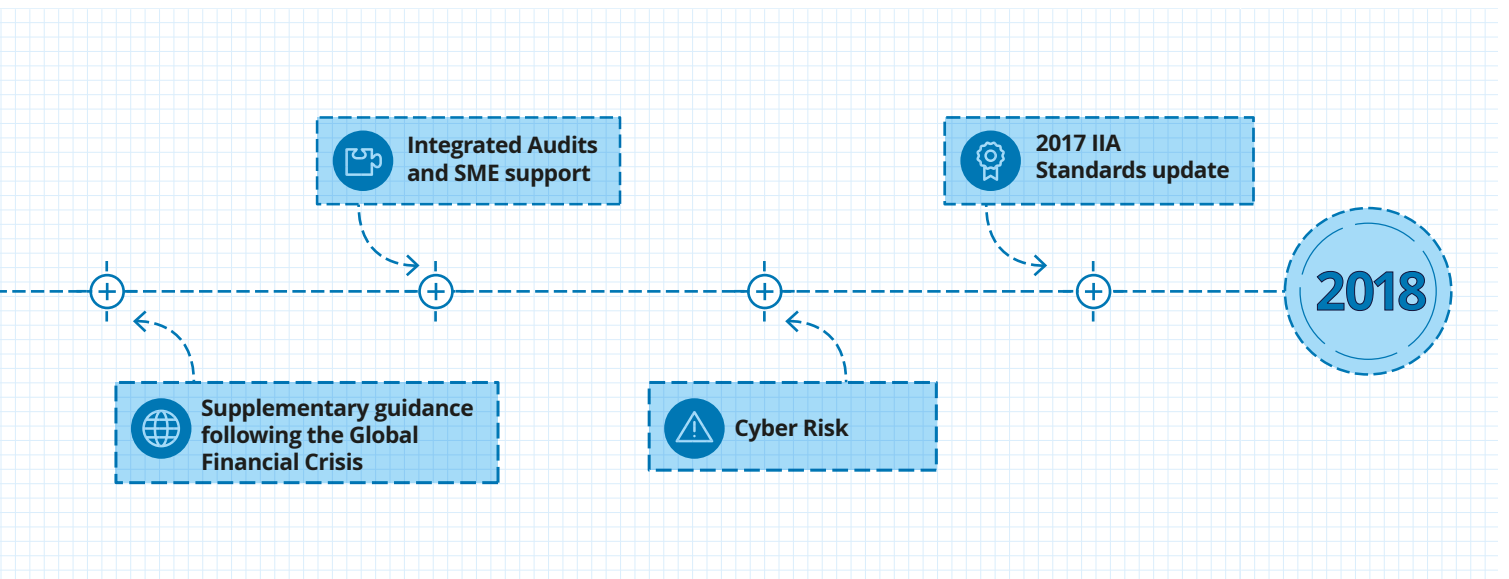
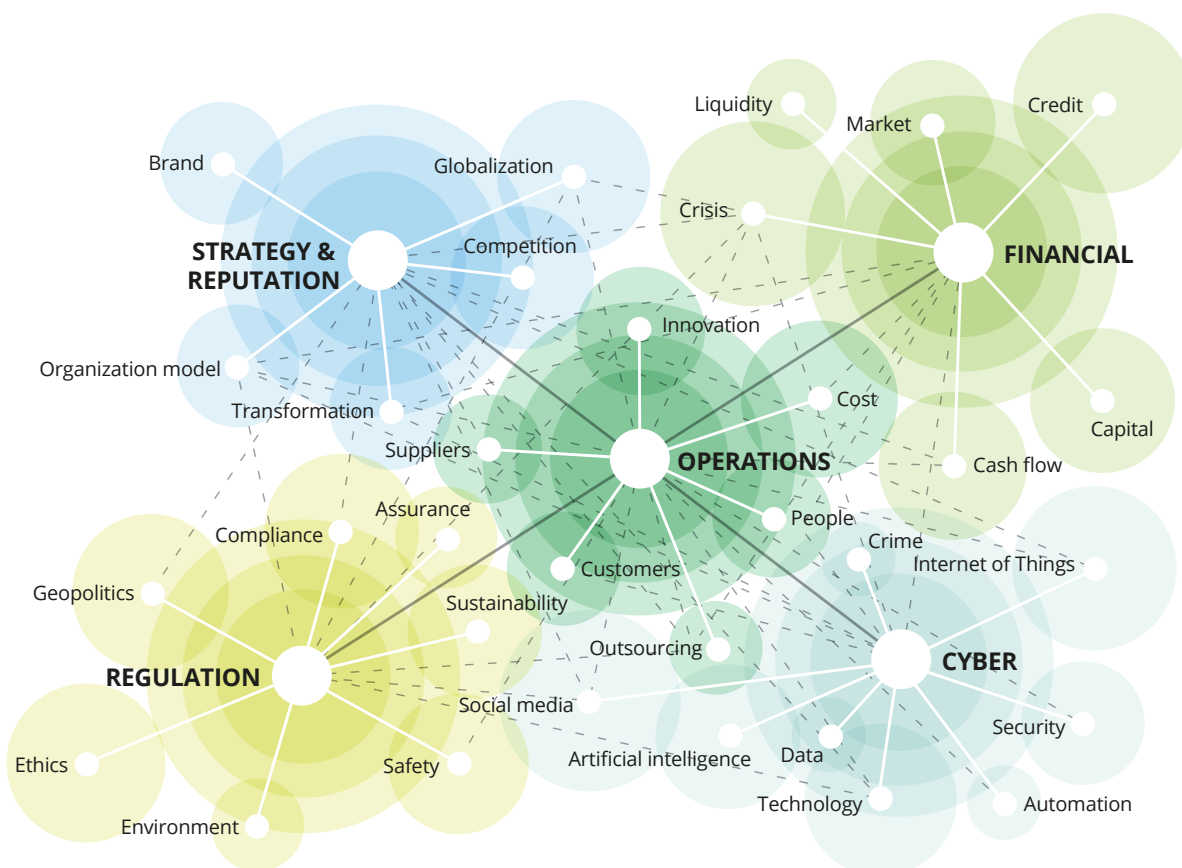

Figure 2. Organizations face increasing uncertainty on multiple fronts



# Assure. Advise. Anticipate.

These three – **assure, advise, and anticipate** – constitute the triad of value that Internal Audit stakeholders now want and need. This has been borne out in numerous Deloitte external quality assessments (EQAs) conducted for Internal Audit functions in a range of industries, in interviews with more than 200 senior executives and audit committee chairs, and in numerous Deloitte research surveys with chief audit executives and heads of Internal Audit<sup>1</sup>.

These key sources of opinion have clearly said that:



**Assurance** constitutes and remains the core role of Internal Audit. Yet the range of activities, issues, and risks to be assured should be far broader and more real-time than they have been in the past. Assurance on core processes and the truly greatest risks is essential but so is assurance around decision governance, the appropriateness of behaviors within the organization, the effectiveness of the three lines of defense (LoD), and oversight of digital technologies. Assurance is central to Internal Audit's role but must not be the limit.



**Advising** management on control effectiveness, change initiatives, enhancements to risk management related to the three LoD and other matters – including business effectiveness and efficiency – falls well within Internal Audit's role and stakeholders' expectations. All sources confirm that a strong advisory role is key to maximizing the value of Internal Audit.



**Anticipating** risks and assisting the business in understanding risks, and in crafting preventative responses, transforms Internal Audit from being a predominantly backward-looking function that reports on what went wrong to a forward-looking function that prompts awareness of what could go wrong, and what to do about it, before it happens. Internal Audit becomes more proactive and, through its assurance and advisory roles, helps management intervene before risks materialize.

We'll examine these three dimensions of value in more depth in this document, and, for now, simply assert that delivering on the assure, advise, anticipate value proposition calls for more innovative, technology-driven approaches – hence, Internal Audit 3.0.

## Internal Audit 3.0 – System overview

Assure, advise, and anticipate form the core value proposition of Internal Audit 3.0, covering the basics while advancing into activities that will deliver new value to the organization. The three darkly shaded areas – and the brief descriptors under assure, advise, and anticipate – designate the core features of Internal Audit 3.0 in Figure 3.

The assure, advise, anticipate value proposition is enabled through:

- Digital assets, which have already begun to transform Internal Audit work, and are about to revolutionize it
- Skills and capabilities, which position Internal Audit to improve the interface with stakeholders and better meet their needs
- Enablers, which engage the system to deliver new value in desirable ways

Thinking that the same people operating in the same way with the same resources can deliver the value that stakeholders need now, let alone going forward, amounts to a failure of imagination. Internal Audit 3.0 challenges Internal Audit leaders to stretch their thinking, methods, and relationships to new, broader, deeper dimensions. To adopt the elements of Internal Audit 3.0, functions have to truly understand what stakeholders value and work in ways that help improve quality, drive efficiencies, and re-think traditional assumptions.

This publication introduces select aspects of Internal Audit 3.0 with other elements covered in detail through separate publications, such as Agile Internal Audit<sup>2</sup>. For further information on Internal Audit 3.0, please see our contacts page at the end of this document and access our latest thinking at [deloitte.com](https://www.deloitte.com).

In the pages that follow, we explain further what Assure, Advise and Anticipate means in the context of Internal Audit 3.0.

Figure 3. Internal Audit 3.0 – System overview

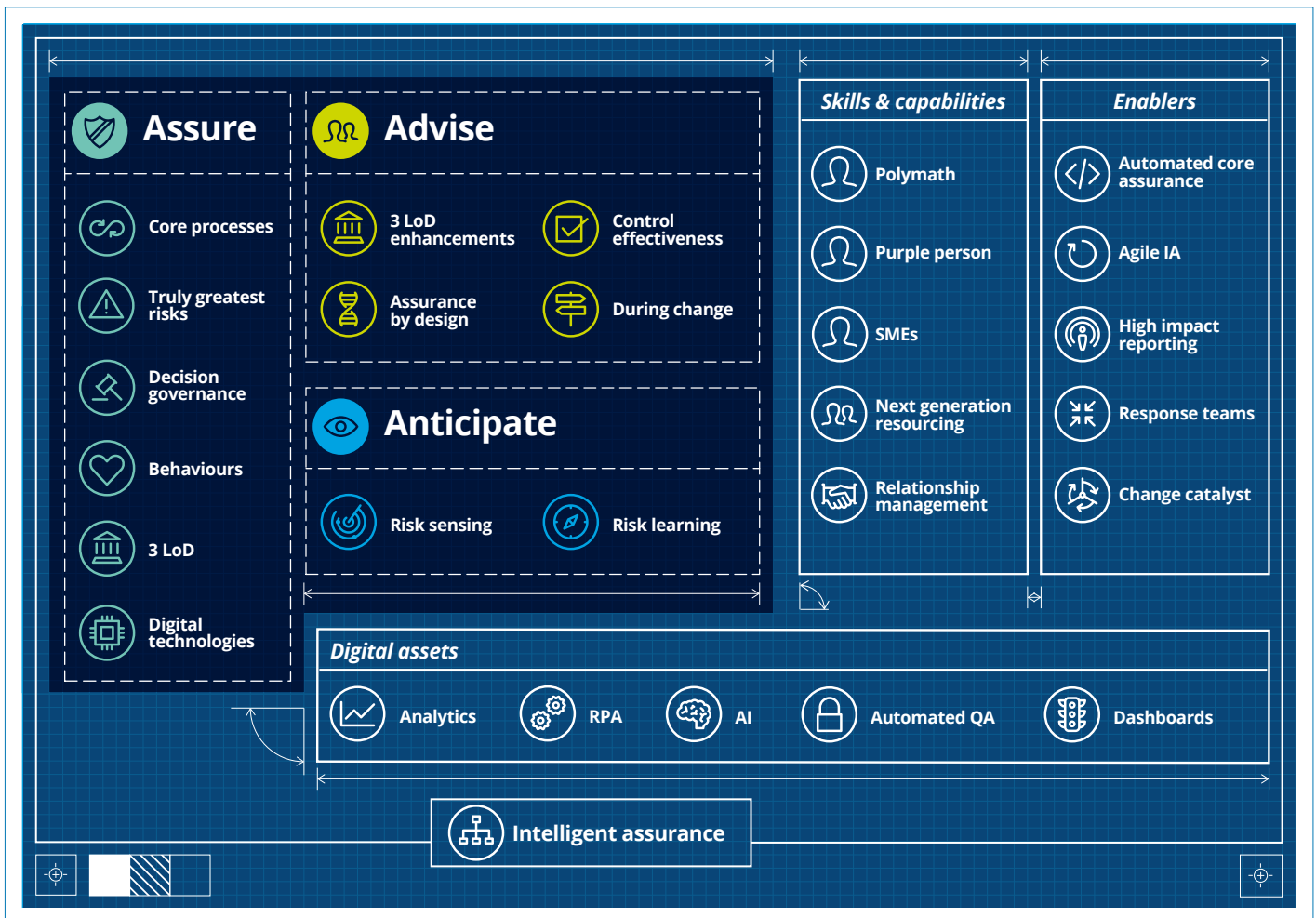





# Assure

The core – but not the limit – of Internal Audit

The “Assure” component of Internal Audit 3.0, includes six broad features in which the function can provide value (Figure 4).

Figure 4. Six features of assure



Figure 5. Traditional assurance versus automated core assurance

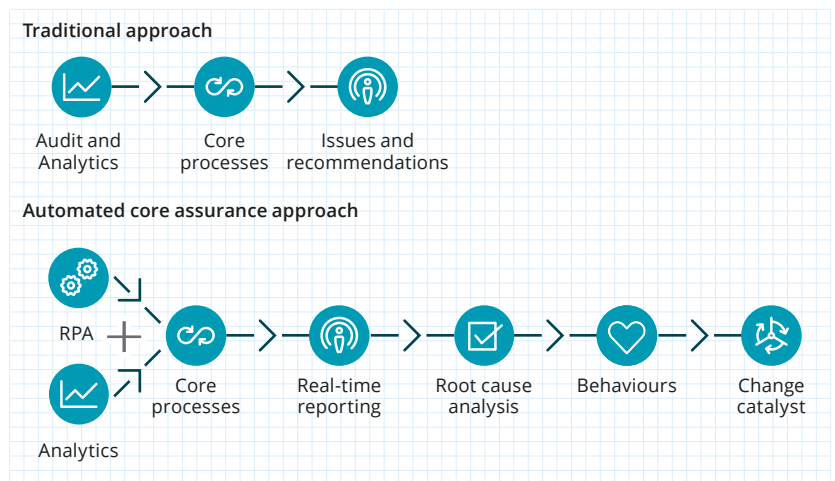

## Core processes – unlocking value through automation

Internal Audit planning aims to balance assurance around two features – core processes and the truly greatest risks to the organization. Internal auditors can cover only so many processes per year and often default to performing audits on a rotational basis in order to find time to also provide assurance around the greatest risks. Yet stakeholders need both types of assurance – assurance that core financial and operational processes in areas like procurement, payables, payroll, and health and safety are working properly, and confidence that the organization’s truly greatest risks (e.g. cyber, digitalization, change management, etc.) are appropriately managed – on a more continual basis.

Now, what if – using digital assets – core assurance could be automated, significantly reducing the resources needed to cover these traditional, core processes on a more continual basis? Automated core assurance harnesses analytics, robotic process automation (RPA), and artificial intelligence (AI) to monitor controls and flag non-conformance in real time. Combine this with automated reporting, and Internal Audit can communicate non-conformance to the business so they can remediate immediately, rather than only being able to check the controls every few years under a rotational audit plan scenario.

Figure 5 illustrates the contrast between the traditional approach and automated core assurance.

The chief benefits of automated core assurance are that it:

- Eliminates the tradeoff between core process assurance and strategic risk coverage (Internal Audit can deliver both)
- Enables allocation of resources to address the truly greatest risks
- Frees resources to analyze why issues occur, including behaviors that contribute to noncompliance, and to remediate issues
- Shifts Internal Audit’s role from identifier of issues to partner in developing solutions, because audits begin with known issues
- Enables Internal Audit to leverage its knowledge, position, and experience to help the business to improve processes and controls

Automated core assurance is an important element within Internal Audit 3.0. It automates what can be automated, and applies human resources where they will yield the greatest value, while providing more effective assurance. It also exemplifies Internal Audit 3.0: in that it leverages technologies such as analytics and RPA to provide real-time monitoring and testing, while repositioning Internal Audit from reporter of historic issues to strategic business partner.

#### **Assurance around behaviors**

Management and employee behaviors drive risk. Luckily, with Internal Audit 3.0, Internal Audit is positioned to provide assurance around behaviors in three key areas: individual accountabilities and whether people are fulfilling theirs, operational discipline and whether people understand and implement controls, and ownership of remediation within the second- and first-line functions. Assurance in these three areas can significantly deepen insight into people's attitudes and conduct around risk and controls.

#### **Assurance around digital technologies**

Many organizations are adopting new and emerging digital technologies. The rise of robotics and AI presents new and specific risk areas that are less understood.

Internal Audit urgently needs to address new and emerging digital technologies from an assurance standpoint because the threats posed by people writing, purchasing, and adopting apps and other digital capabilities, including those related to the Internet of Things (IoT), are real and here now.

This is where new skills and capabilities, and internal auditors with different skills and experiences, will be needed, including 'purple people' who possess a mix of business and technology skills, and understand cognitive systems in a business context. Additionally, Internal Audit functions may need more 'polymaths' – experts who can ask the right questions, understand stakeholder needs, see the real risks, and embrace new ways to provide assurance. This is not just about having someone review the governance around, say, application development and data access; it's about having people who can understand the risk exposures created by the nature of a specific AI or RPA application and the assumptions being made about them. These skills are in short supply, but quite necessary.

“Automated core assurance is an important element within Internal Audit 3.0. It automates what can be automated, and applies human resources where they will yield the greatest value, while providing more effective assurance.”

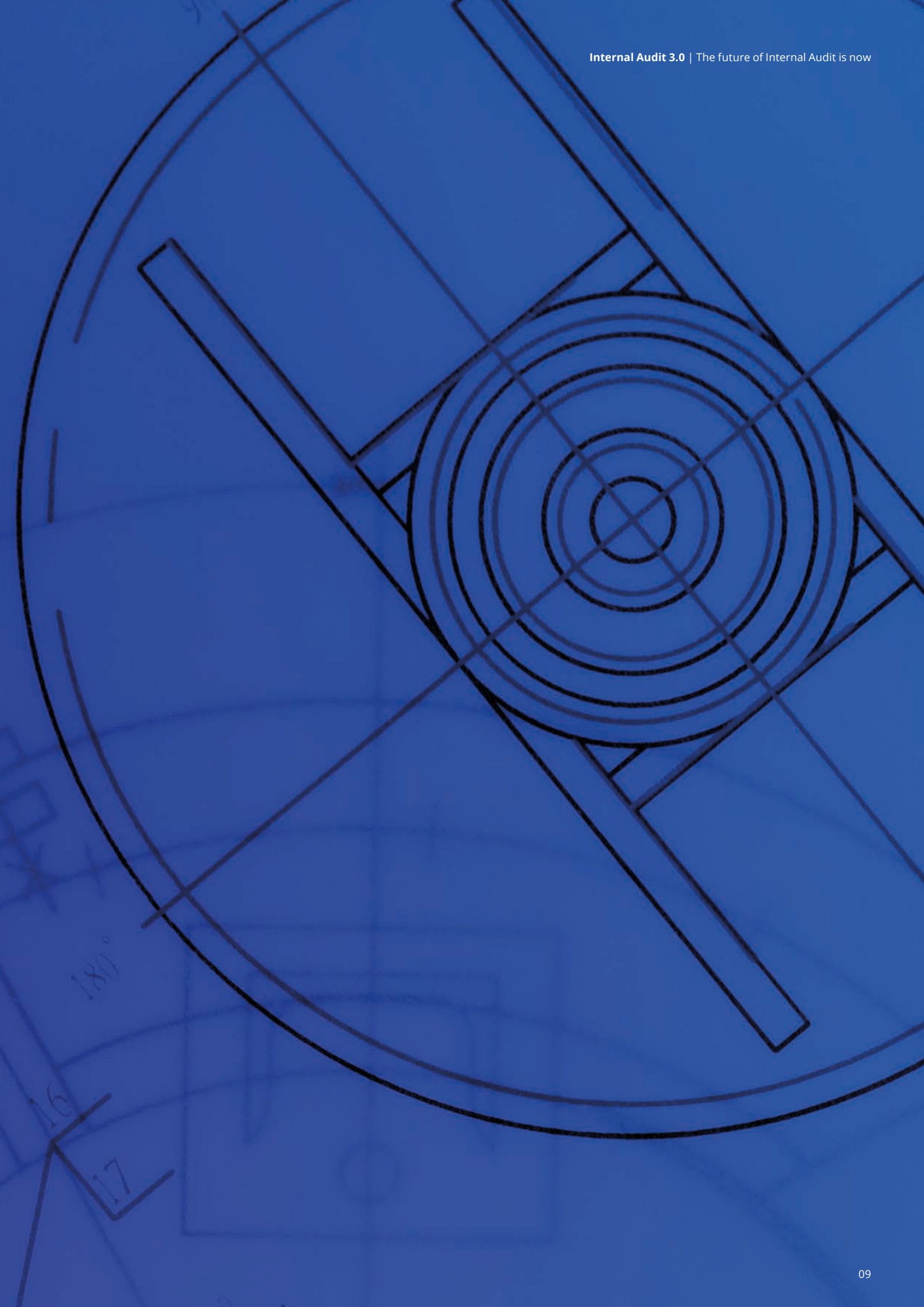

# Advise

Maximizing value to stakeholders

The “Advise” component of Internal Audit 3.0 comprises four broad features in which the function can deliver new and needed value (Figure 6).



## Independence: Success factor or limiting factor?

In our experience, too many internal auditors use “independence” as a crutch, as an excuse to stay in their lane and avoid offering insights and opinions when most stakeholders have said that is what they truly want. This can relegate the function to reporting on the past, which is not the wave of the future.

Independence is important and must not be disregarded, but Internal Audit functions can make informed decisions about which types of advisory services do not compromise functional or individual auditor independence.

Typically, Internal Audit advisory services require the function to provide a point of view, challenge management, or deliver real-time insights. Such services can join the dots which others don’t see in their entirety, connect people, and be a catalyst for change. Internal Audit functions have a privileged position within organizations, and not making use of this position is a missed opportunity.

Independence means freedom from conditions that create the risk of bias – and freedom to have a point of view and to provide insights supported by data, research, peer practices, and experience. Using “independence” to opt out of assisting the business benefits no one. Under Internal Audit 3.0, functions can respect independence whilst advising the business through promoting objectivity, integrity, and professionalism.

Figure 6. Four features of advise



### Enhancements to the three lines of defense

In Internal Audit 3.0, functions advise the second and first lines of defense on ways to improve their own assurance capabilities. While still maintaining their objectivity and independence, internal auditors can provide advice and share methods and tools. The goal is to provide assurance where it can be done most efficiently and effectively – and as close as possible to real-time. Regarding independence (see sidebar), Internal Audit should clearly not be making management decisions or designing the controls it will be auditing. But it is completely legitimate, and, in our view, squarely within the function’s role, to assist the first and second lines in improving their own capabilities.

Internal Audit 3.0 can usefully shift certain assurance activities to the first and second lines, but this must be done properly. For example, if internal auditors develop an analytical tool, which could be adopted by the first and second line, care should be taken to make sure appropriate safeguards are in place, but this should not preclude functions from sharing knowledge and tools for the benefit of the wider organization. The approach will differ for different industries and different organizations.

### Control effectiveness

Assurance around control design effectiveness is table stakes; the most useful advice for the business comes at the time the controls are being designed. The business benefits far less when Internal Audit weighs in with only a review of control design after implementation. Internal auditors should observe those projects and provide real-time feedback. Safeguards to preserve independence can and should be established, by the business units or committees in question and by Internal Audit, but Internal Audit should be at the table and provide its control expertise during the design phase.

### Advising during change

Internal Audit should also have a seat at the table on strategic projects and transformation initiatives, not only to provide assurance on change projects but to contribute to the quality of discussion by calling out concerns, challenging management's approach to risk management and advising on ways to enhance and provide assurance. In financial services in some jurisdictions, Internal Audit has the right to attend Executive Committee meetings and other key management decision-making venues, for this very purpose. This doesn't always happen now.

### Assurance by design

Internal Audit can help management to implement mechanisms in the business that eliminate or reduce the need for the second or third line to provide assurance on processes or controls. The ideal situation would be to reach a point where the system, rather than a control that could be worked around, simply generates non compliance reports. The basic question is: How can we design-in and build-in mechanisms that reduce the amount of assurance that human beings have to provide? This advice stands apart from the issue of providing reviews and assurance around how well a control mitigates a risk. In fact, the goal of assurance by design interlocks with, and supports, the goals of real-time assurance and reporting, and automated core assurance.

Indeed, virtually all features of Internal Audit 3.0 interlock and support one another.

“Internal Audit can help management to implement mechanisms in the business that eliminate or reduce the need for the second or third line to provide assurance on processes or controls.”

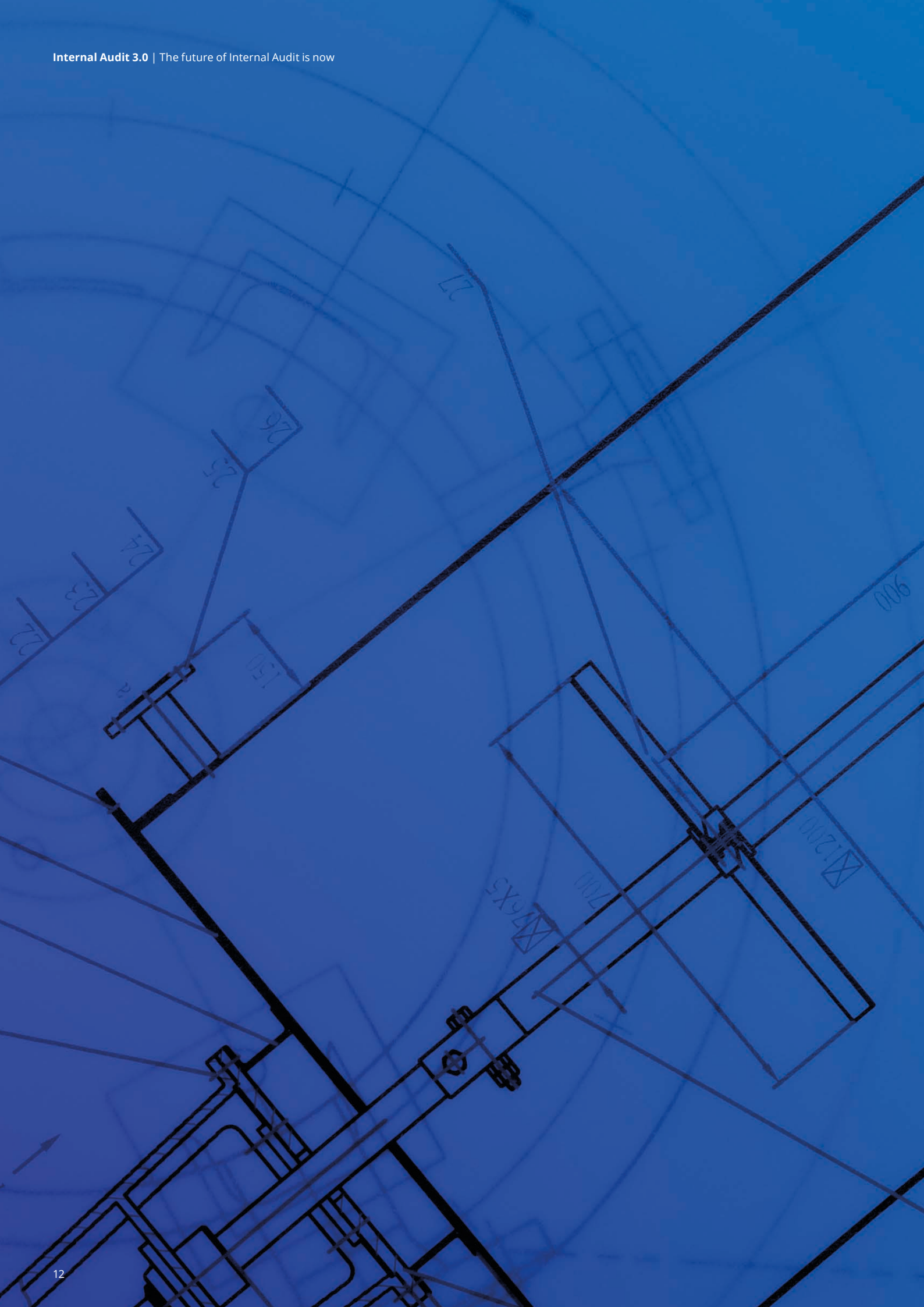

# Anticipate

Delivering forward-looking insights

With unparalleled access to information within the organization, increasing capabilities to use external data, and an enterprise-wide view of the organization, Internal Audit is in the ideal position from which to anticipate risks and issues that could affect the organization's ability to reach its goals.

## Risk sensing: Viewing the risk landscape

Currently available risk sensing platforms monitor risk indicators based on internal or external data, or combinations of the two. For example, many organizations monitor social media for customer sentiment and reputational risks, or newsfeeds and regulatory filings, and apply analytics to identify themes and trends. Financial services and large industrial companies monitor central bank policies to anticipate interest rate movements, and the impacts on their businesses. Many organizations monitor internal management information to identify trends in financial or operational performance, customer behavior, product defects, and other issues that could affect the business.

Risk sensing, which combines advanced analytics with human judgment, provides a panoramic view of risk, extending well beyond traditional risk registers of identified risks. Risk sensing focuses on emerging, often unknown risks, and thus stands among the key capabilities for anticipating issues and problems and delivering insights. Risk sensing also enables real-time and continuous risk assessment, moving away from the traditional annual risk assessment approach. Used effectively, risk sensing can help enhance Internal Audit's understanding of risk and focus assurance activities accordingly.

## Risk learning: Getting to why

Risk learning, or cognitive risk anticipation, applies analytics to risk events and surrounding factors to tease out causal relationships. If a risk event occurs, analysts can examine what else occurred before, during, and after the event. Over time, by applying pattern recognition and root cause analysis to a growing database of events and factors, the organization can isolate correlations, sequences of events, and causes and effects. This positions management to take proactive steps to avoid or mitigate risk events. It also positions Internal Audit to conduct proactive assurance work related to those steps. Risk learning takes both Internal Audit and the organization well beyond the limits of traditional risk-based planning, while reducing the level of "unknown unknowns" that management faces.

## Upgrading to Internal Audit 3.0

Digital assets, skills and capabilities, and other enablers are what make Internal Audit 3.0 a reality.

How an Internal Audit group develops, accesses, and deploys digital assets, skills and capabilities, and enablers will depend on the function, organization, and stakeholders. The essential first step here is to develop a shared vision for Internal Audit 3.0 and then to chart a path toward realizing that vision.

For some, this has involved Agile Internal Audit – our method of applying practices from agile development to Internal Audit work – which has already begun to revolutionize forward-thinking functions, as explained in our related publication. For others, it may be risk sensing, or automated core assurance. Internal Audit 3.0 is about helping Internal Audit functions to keep pace with change, create value, remain relevant, and enhance impact and influence.

## “The future of Internal Audit has become clear, and the time to upgrade is now.”

### **The inevitability of change**

As the saying goes, “There are those who make things happen, those who watch things happen, and those who ask, ‘What happened?’”

The stakes are too high, for both Internal Audit and the organization, for Internal Audit to be in the latter group.

Stakeholder needs have become clear enough for Internal Audit to engage in true transformation. And that is what is called for, in the context of a vision for the function and its role in the organization. With a vision – collaboratively developed, clearly articulated, and strongly supported – functions can upgrade to Internal Audit 3.0, providing stakeholders with its true worth.

We have repeatedly seen well-developed visions and diligent follow-through work. In our Chief Audit Executive transition labs, in Internal Audit transformation initiatives, and in projects that promulgate automated assurance, advanced analytics, Agile Internal Auditing, and high-impact reporting, we have seen Internal Audit leaders and staff embrace change, raise stakeholder expectations, and then deliver on those expectations.

The future of Internal Audit has become clear, and the time to upgrade is now.



# Contacts

Please contact our team if you would like to discuss or need help defining the future of your Internal Audit function.



**Terry Hatherell**  
**Global Internal Audit Leader**  
thatherell@deloitte.ca



**Sandy Pundmann**  
**United States Internal Audit Leader**  
spundmann@deloitte.com



**Kris Wentzel**  
**Americas Internal Audit Leader**  
kwentzel@deloitte.ca



**Sarah Adams**  
**Global IT Internal Audit Leader**  
saradams@deloitte.com



**Peter Astley**  
**EMEA Internal Audit Leader**  
pastley@deloitte.co.uk



**Neil White**  
**Global Internal Audit Analytics Leader**  
nwhite@deloitte.com



**Porus Doctor**  
**Asia Pacific Internal Audit Leader**  
podoctor@deloitte.com



**David Tiernan**  
**UK Internal Audit Innovation Lead**  
datiernan@deloitte.co.uk

# Irish contacts

Please contact our team if you would like to discuss or need help defining the future of your Internal Audit function.



**Colm McDonnell**  
**Partner,**  
**Risk Advisory Leader**  
cmcdonnell@deloitte.ie



**David Kinsella**  
**Partner**  
**Risk Advisory**  
davkinella@deloitte.ie



**Eileen Healy**  
**Partner**  
**Risk Advisory**  
ehealy@deloitte.ie

# Endnotes

1. Evolution or irrelevance: Internal Audit at a crossroads Deloitte Global Chief Audit Executive Survey, Deloitte Development LP, 2016 <<https://www2.deloitte.com/content/dam/Deloitte/global/Documents/Audit/gx-deloitte-audit-executive-survey-2016-print.pdf>>
2. **Understanding Agile Internal Audit:** <https://www2.deloitte.com/content/dam/Deloitte/us/Documents/finance/us-advisory-agile-internal-audit-part1-introduction-to-elevating-performance.pdf>  
**Putting Agile Internal Audit into Action:** <https://www2.deloitte.com/content/dam/Deloitte/us/Documents/finance/us-advisory-agile-internal-audit-part2-putting-agile-ia-into-action.pdf>



100 →

100 →

100 →

100 →

100 →

100 →

100 →

100 →

# Deloitte.

Deloitte refers to one or more of Deloitte Touche Tohmatsu Limited, a UK private company limited by guarantee (“DTTL”), its network of member firms, and their related entities. DTTL and each of its member firms are legally separate and independent entities. DTTL (also referred to as “Deloitte Global”) does not provide services to clients. Please see [www.deloitte.com/about](http://www.deloitte.com/about) to learn more about our global network of member firms.

This communication contains general information only, and none of Deloitte Touche Tohmatsu Limited, its member firms, or their related entities (collectively, the “Deloitte network”) is, by means of this communication, rendering professional advice or services. Before making any decision or taking any action that may affect your finances or your business, you should consult a qualified professional adviser. No entity in the Deloitte network shall be responsible for any loss whatsoever sustained by any person who relies on this communication.

© 2018. For information, contact Deloitte Touche Tohmatsu Limited.

Designed and produced by The Creative Studio at Deloitte, London. J15021