

Monitor  
**Deloitte.**

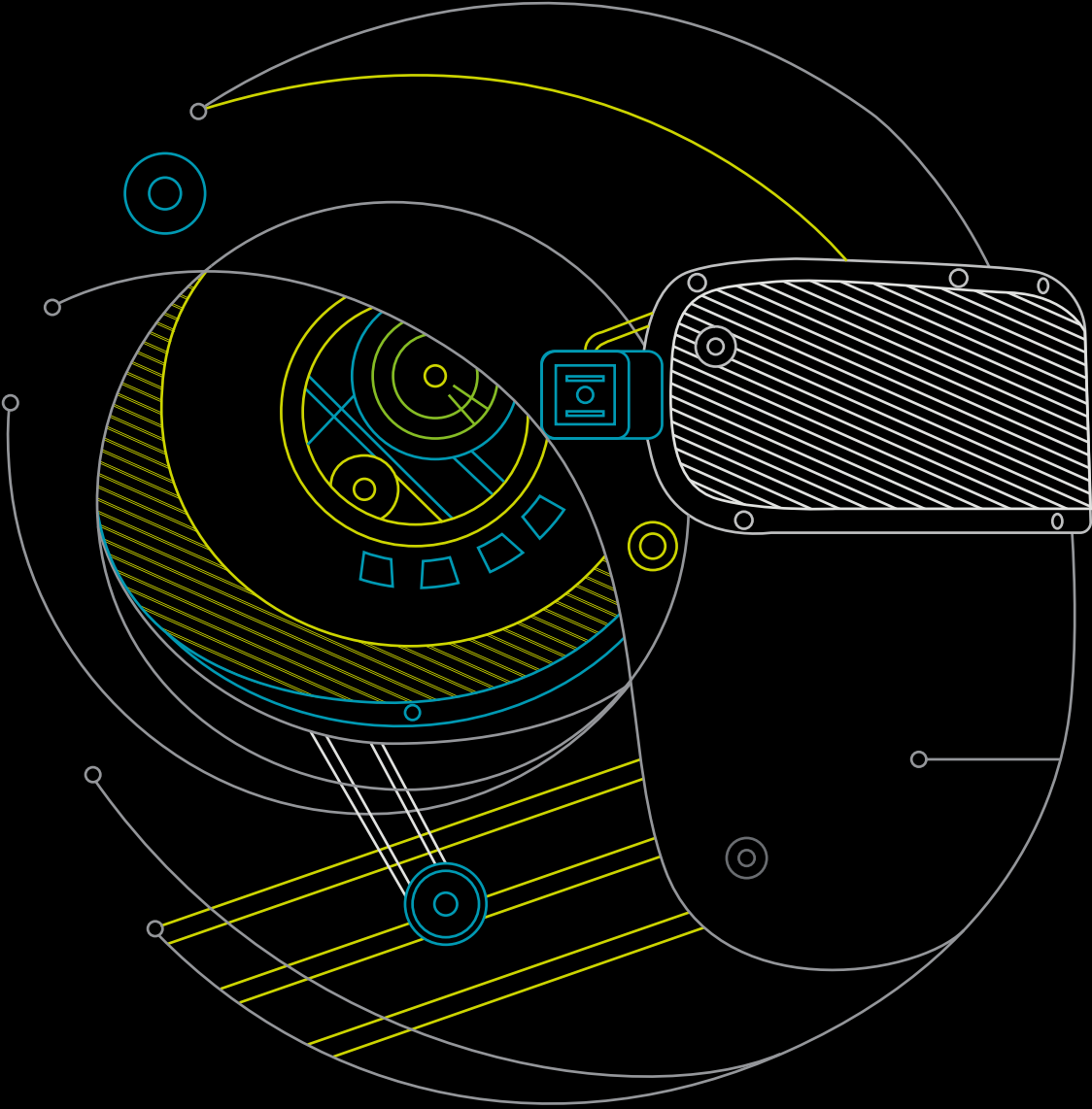

**To be or not to be**

The future of the  
telco business model

center  
for the long view



[www.deloitte.de/de/future-of-telco](http://www.deloitte.de/de/future-of-telco)

Introduction	04
Thinking in scenarios	06
Relevant scenarios based on identified key drivers	10
Critical uncertainties and how they shape our four scenarios	12
Generic key drivers – the same but different	14
Journey into our four scenarios	20
Taking the long view	34
Sources	36
Methodology	37
Contacts	38

# Introduction

The pace of change in the European telecommunications industry is accelerating: the boom years are either over or coming to an end very fast for most telcos. The tech sector has seen enormous disruptive changes affect social life, politics and business. Throughout history, both society and industry insiders have been colossally wrong or totally underestimated markets and gadgets that we couldn't live without today.

In the beginning, the telephone was not expected to be a success story:

- Western Union, who dominated the telegraph industry at the end of the 19th Century, noted in an internal memo: "This 'telephone' has too many shortcomings to be seriously considered as a means of communication. The device is inherently of no value to us".<sup>1</sup>
- In Germany, the first telephone directory was popularly called "the book of 99 fools", as the general public believed the telephone had no future.<sup>2</sup>
- In the 1980s, when the first cell phones were introduced, AT&T forecasted that there will be less than 1 million subscribers in the USA by the year 2000.<sup>3</sup>

There were incorrect predictions about the development of computers, too:

- In 1949, Popular Mechanics magazine forecast that the computers of the future would weigh no more than 1.5 tons.<sup>4</sup>
- Even Steve Jobs, who was well known for his sense of customer needs, was totally wrong when he prophesied no hope for mobile computers: "For the average person, they're really not that useful, and there's not all that much software for them either".<sup>5</sup>

Another major part of the communications industry, the Internet, is a hotbed for wrong predictions:

- Microsoft founder Bill Gates thought the Internet was just hype.<sup>6</sup>
- Ron Sommer, then CEO of Deutsche Telekom, said in 1990 that the Internet was a gimmick for computer nerds and he didn't see any future in it.<sup>7</sup>

The accelerating pace of this change makes predictions hard, so we adopted a more holistic approach – and we now invite you to travel with us into four scenarios for the telecommunications industry in 2030. Our scenario approach does not aim to predict the most likely outcome, but to illustrate what could plausibly happen in the telco world and how market players might deal with many uncertainties along the way.

<sup>1</sup> Cairncross, F. (2001)

<sup>2</sup> Winkelhage, J. (2006)

<sup>3</sup> Lozano, A. (n.d.)

<sup>4</sup> Meigs, J. (2012)

<sup>5</sup> Erdmann, C. (2011)

<sup>6</sup> Handelsblatt (2014)

<sup>7</sup> Pillkahn, U. (2013)



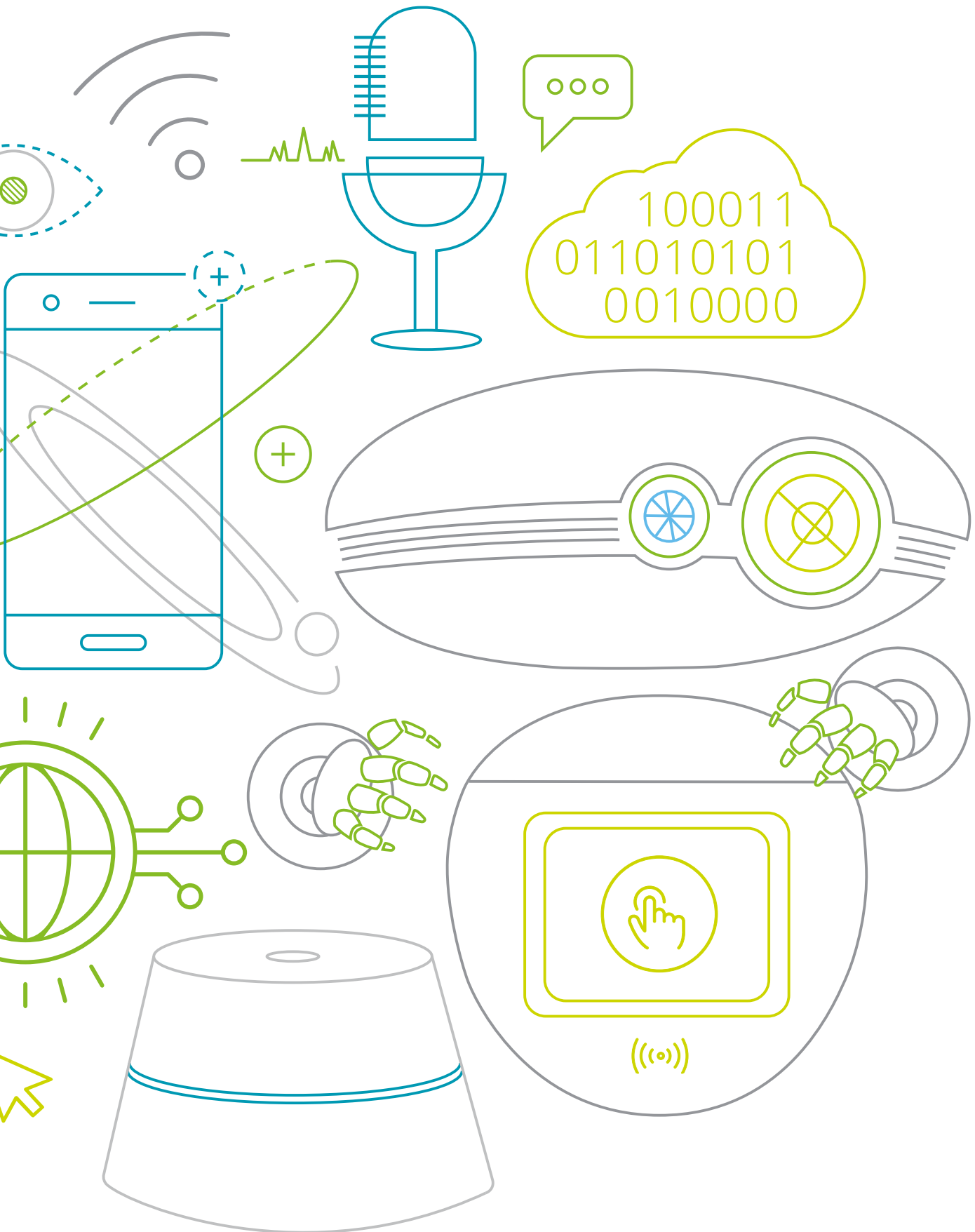

# Thinking in scenarios

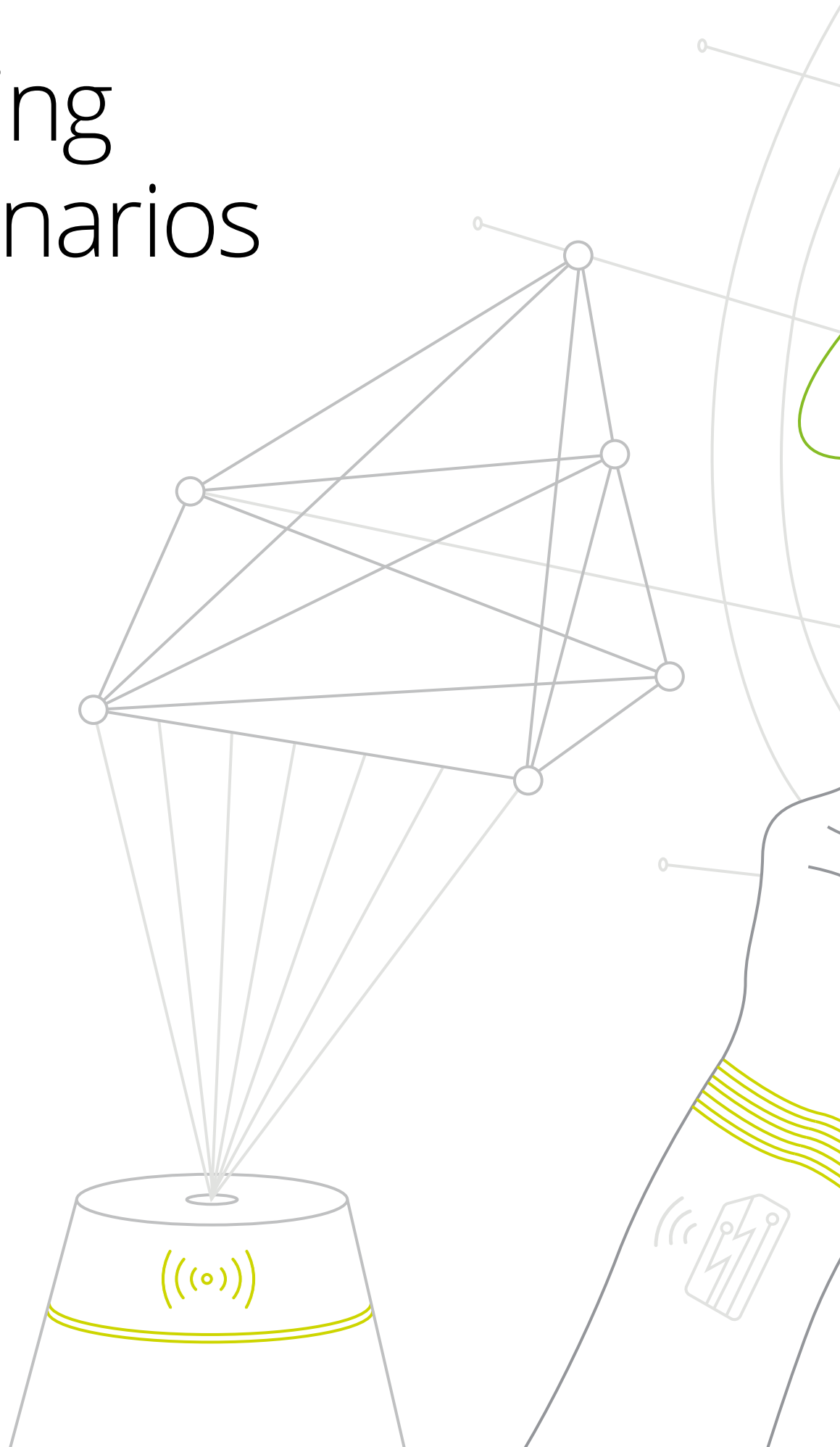

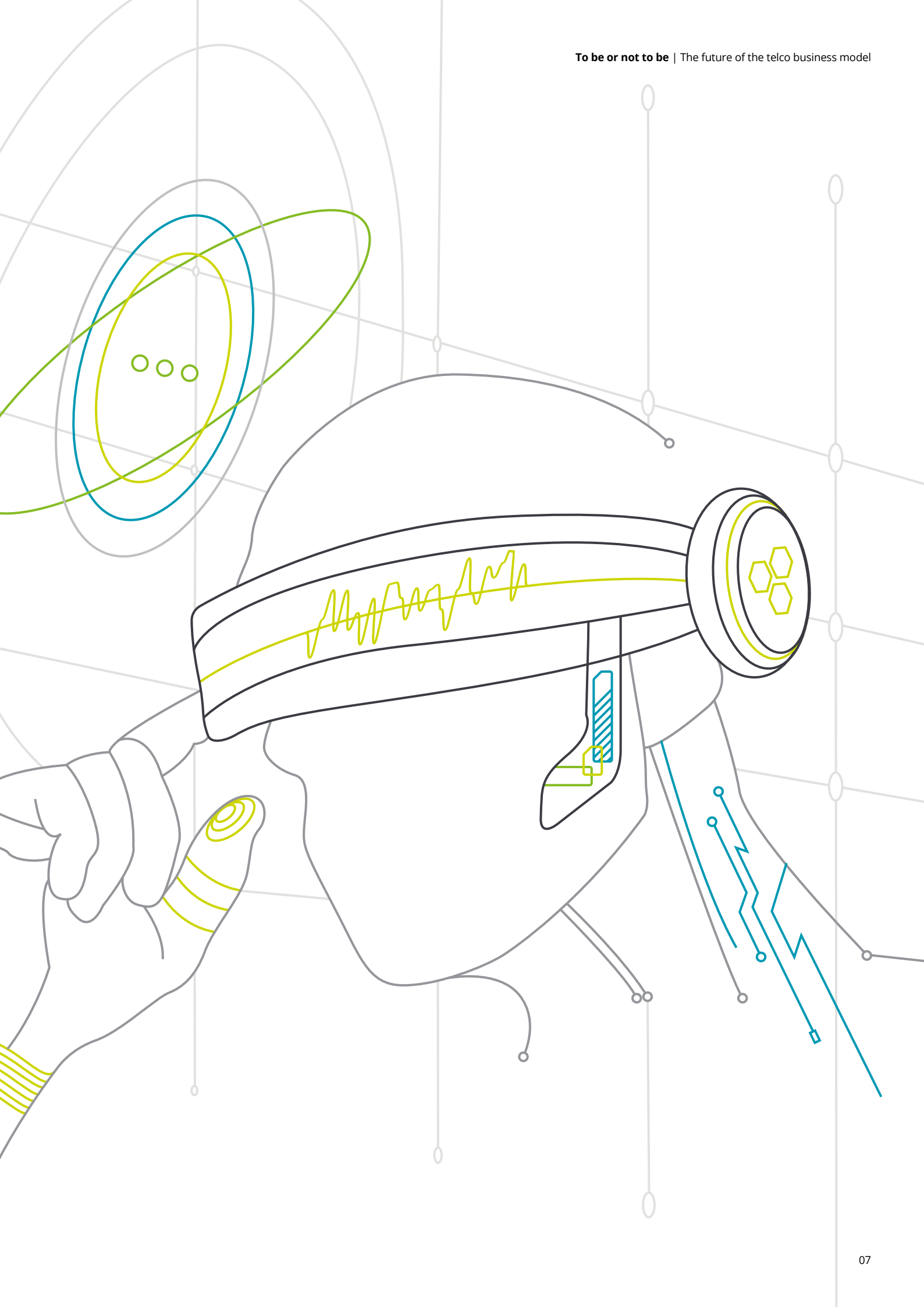

Most of the trends that telcos are exposed to display a high level of uncertainty – they could turn out to be disruptive, lead to exponential change over the next decade, or sink without trace. Shifting customer behavior, with ever-increasing expectations and pressure from both existing and new players in the game, affects their business, while more and more revenue streams either face strong decline or are being taken over by other players such as over-the-top (OTT) players and tech giants, challenging the telcos' traditional business model. Yet the transformation of their core business, coming sooner and faster than foreseen, is pushing telcos to step outside of their traditional thinking and become innovation drivers.

In this uncertain environment, industry stakeholders such as telco companies, vendors, and other investors are asked to consider long-term assets, and the decisions they make today will have a major impact on users, companies, and the economy in the future. As we have seen, traditional analyses struggle with forecasting, since no amount of research can remove all the uncertainties affecting the successful outcome of a decision over decades.

Nevertheless, telco players need to make these decisions, and scenario design is one way to deal with the lack of certainty and look beyond the conventional planning horizon. While predicting the future is usually impossible, scenario design helps to develop robust strategies that will work in different potential futures by highlighting the risks and opportunities of certain strategic issues. Scenarios are stories, narratives about alternative future environments in which today's decisions could play out: they are neither predictions nor strategies. Each scenario models a specific, plausible world of the future which differs considerably from the others. Scenario design emphasizes large-scale forces that might move the future in different directions.





Each scenario models a specific, plausible world of the future which differs considerably from the others. Scenario design emphasizes large-scale forces that might move the future in different directions.

# Relevant scenarios based on identified key drivers

Extensive research based on Natural Language Processing algorithms, desk research, and expert insights generated a long list of drivers that could shape the future of the telecommunications industry. These were then analyzed and clustered into five categories: social, technological, economic, environmental, and political. The drivers were then rated for their degree of uncertainty and their impact on the telecommunications industry.

Examples are the ownership of network innovation, which is an important success factor in the telco ecosystem. Network innovation could either be driven by the telcos themselves or outsourced to other players in the value chain, such as hardware vendors, while telcos merely use the network.

Another example of a high impact and high uncertainty driver is the role of OTT players, who could become a significant threat for telcos as their power in the market increases. OTTs could take over customer relations if users perceive connectivity as a necessary but basic utility. It is also imaginable that the telcos own the user data, analyze their needs, and use this knowledge and insight to monetize the relationship.

The best way to predict the future is to create it.

**Peter Drucker**

Fig. 1 – Driver evaluation according to degree of impact and degree of uncertainty



# Critical uncertainties and how they shape our four scenarios

All high impact and uncertain drivers in the zone of interest were clustered into critical uncertainties based on feedback from industry clients and expert knowledge from the Deloitte EMEA TMT Community. These critical uncertainties were then enriched with other drivers which are less uncertain and have less impact, in order to enhance our understanding of the concepts the clusters represent. These critical uncertainties were then tested for inter-dependence and the relevance of their combination. This process led to a scenario matrix with two axes, "Ownership of the (network) technology layer" and "Dominance of the traditional customer relationship", as critical uncertainties.

The "Ownership of the (network) technology layer" axis can tip in one of two directions. At one end, telcos own the network layer, at the other they are fully separated from the network layer, which is dominated by vendors as the main source of innovation, while telcos outsource most tasks. This cluster is driven by network innovation, bandwidth, and latency developments, the mobile communication cell network structure in the form of 5G/6G, the Internet of Things, and also Software Defined Networks.

The second critical uncertainty, "Dominance of the traditional customer relationship", can logically also tip in one of two directions. At one end, telcos as primary providers of value-adding services like communications and media access continue to own the traditional customer relationship, but at the other they could also be fully isolated from the customers, who are served by various providers such as OTTs or technology companies. For example, IoT providers could insert themselves between

users and network, or device producers might equip their devices with virtual SIM cards that choose the best provider in a dynamic process. This cluster contains various drivers such as customer service and contact, competitive development, willingness to pay for telco services, the number of personal devices used, (un)bundling of services, the role of OTT players, and data protection and privacy. With the help of our scientific scenario development approach, these critical uncertainties shaped four possible scenarios.

In "The engineer strikes back", telco operators master both customer relationships and the technology layer. In the second scenario, "The new wholesale truth", telcos have been driven out of the customer domain but remain masters of the technology. Telcos retain the primary customer relationship but transfer the technology entirely to vendors in "The virtual telco". In the last scenario, "A vendor brand", telco players are driven out of both domains.

Fig. 2 – Four scenarios for 2030

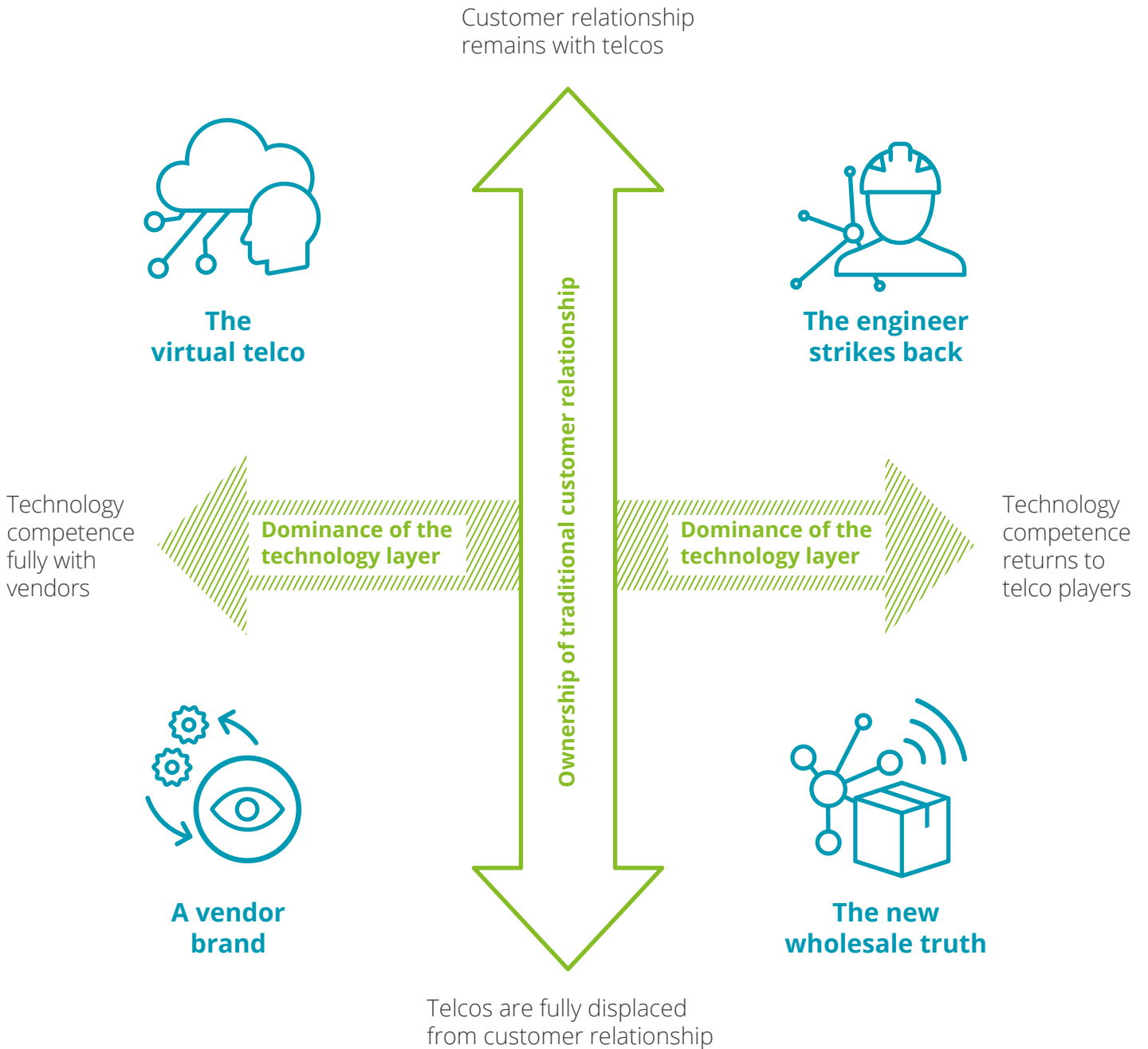

# Generic key drivers – the same but different

Regardless of the scenario, some general topics emerge. Most of them reflect the external environment, such as customer behavior, data privacy, and regulation, while other factors clustered under operational excellence can be influenced by the telcos themselves.

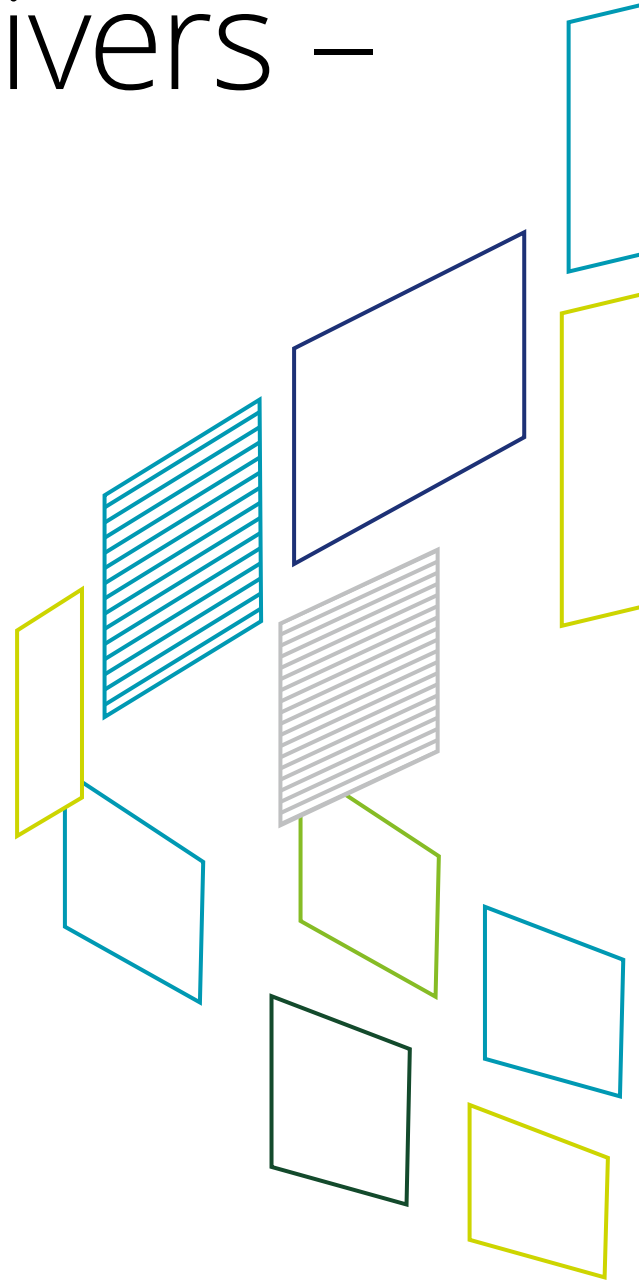

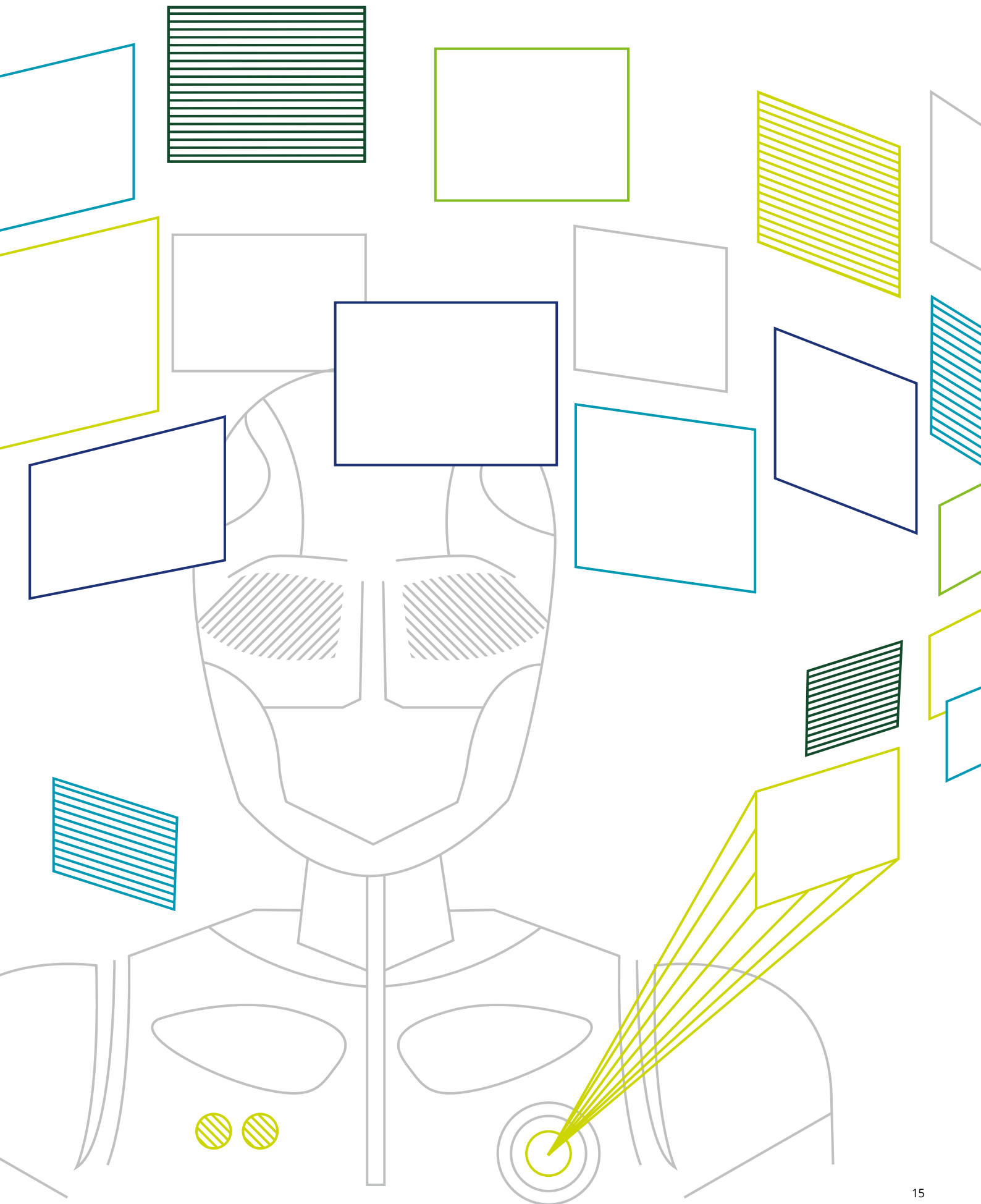

### Customer behavior

Today, 62% of under-24-year-olds look at their phone within 15 minutes of waking up, compared to 36% of the overall population.<sup>8</sup> With the accelerating pace of technological development, customer behavior in 2030 will be significantly different from today's world, since many aspects of our lives will be interconnected and 'smart', featuring remote-controlled gadgets, automatic re-orders from fridges, and autonomous vehicles. The way we communicate and interact with technology will change enormously, from augmented reality to virtual reality and eventually holographic communication. The worldwide virtual reality market is already worth USD 1bn; by 2020 the German market will have reached this size on its own, with further exponential growth expected subsequently.<sup>9</sup>

More than a third of the population will belong to a generation that has replaced display-focused with conversation-focused communication, like Amazon's Alexa. Data analytic capabilities enable highly proactive digital personal assistants (PAs) that can take part in any sphere of daily life.<sup>10</sup> PAs will be connected to the human body by innovative sensors that can read brainwaves, and therefore interpret most interactions and analyze human desires. As early as 2017, more than 300 million smartphones sold globally have neural network machine-learning capabilities on board.<sup>11</sup>

Technological progress will enable average smartphones to process in petaflops with their petabyte of storage capacity and connection speeds of several gigabits per second. This will facilitate new services and user experiences, but also require greater bandwidth. We are already seeing a massive

**Fig. 3 – VR-Revenue forecast for Germany**

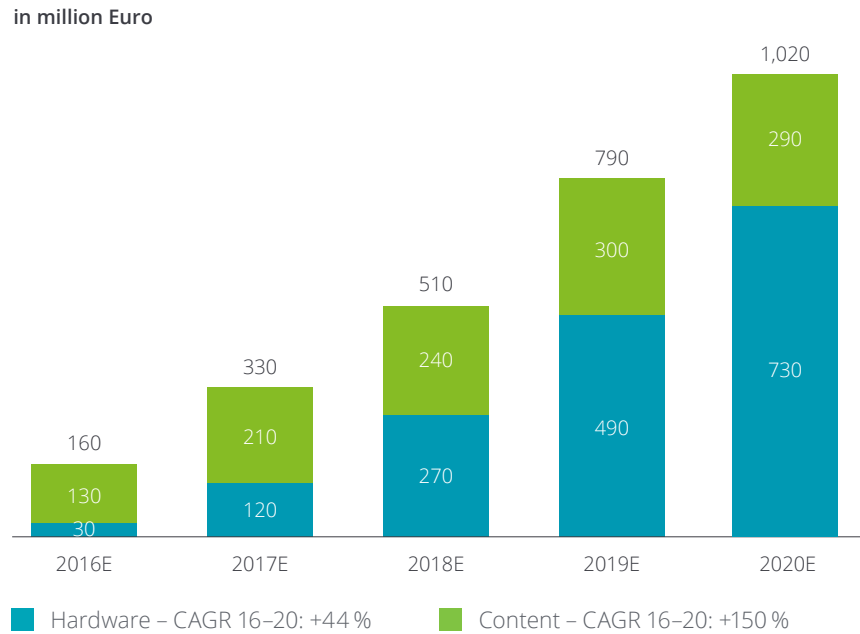

Sources: Deloitte

increase in data generated by mobile devices, from 17% of total data traffic in 2013 to 27% in 2020, a development that is likely to accelerate in the future.<sup>12</sup>

Customers expect perfect connectivity, with bandwidth matching their demand wherever they are and whenever they need it. Most customers will have little interest, or none, in which underlying infrastructure connects them. Technological standards are therefore not a major differentiator for telcos, who are perceived as utility companies providing a commodity. Consumers have a low willingness to pay, basic connectivity is considered a free service on the

lowest level of Maslow's hierarchy of needs. This is encouraged by an increasing number of connections and the amount of data transferred, making lower marginal costs possible. However, additional premium services for the digital economy can drive a higher willingness to pay.

A key differentiator will be a seamless journey throughout the customer's lifetime: from first contact to signing contracts via online channels or shops to incident management and retention.

<sup>8</sup> Böhm, K. (2015)

<sup>9</sup> Lutter, T., Meinecke C.-M., Prescher, D., Böhm, K. & Esser, R. (2016)

<sup>10</sup> Wigginton, C. (2017)

<sup>11</sup> Sallomi, P. & Lee, P. (2017)

<sup>12</sup> Briggs, B. & Hodgetts, C. (2017)



### Data privacy and security

As Francis Bacon said in 1597, “knowledge is power”. This knowledge is contained in various data formats that humans have been trying to encrypt for thousands of years. The interconnectedness of every aspect of life that the digital world makes possible leads to a vast increase in data, which offers new possibilities for encrypting and decrypting data. As a result, data protection is a major topic, as reflected by the high-value market for security solutions.

In all scenarios, computational processing speed will increase enormously, leading to the emergence of new data protection methods. At the same time, these improvements will be challenged by attempts to crack the security solutions. There will thus be more and more need for data protection, as the digital universe is growing exponentially and is set to reach 44 zettabytes in 2020, 10 times more than in 2013.<sup>13</sup> Not only single data points need to be protected, but also connected IoT devices and entire networks – in all scenarios. Stuxnet is an example that has shown how a computer worm can infiltrate a computer system and sabotage complex infrastructures. Network security tries to protect the usability and integrity of networks in different dimensions by controlling access, preventing data loss, and actively defending the network against attacks. New technologies such as the introduction of software-defined networks will bring advantages and disadvantages in terms of network security. In all scenarios, we therefore see a neck-and-neck race between encryption and decryption technologies and also between network protectors and network intruders – which forces the network owners, i.e. telcos or vendors, into mitigating these risks.

Apart from the technological possibilities, data privacy is also driven by a social component: customers’ demand for anonymity and privacy concerns. The absence of network security and active data protection systems has diminished customers’ trust in the international technology giants (as shown in the Snowden incident). At the same time, it has opened opportunities for local telco carriers to position themselves as protectors of data privacy and gain a competitive advantage. Apart from external data abuse, the internal processing of data is also viewed skeptically by consumers. At present, 43% of consumers would offer up their personal data in exchange for special offers and discounts, while 39% of consumers said they would share their information if it meant solving customer service problems faster. Since Millennials display a greater willingness to share their data (49%) than Baby Boomers (38%), we expect future customers to be more likely to share their data with corporations.<sup>14</sup>

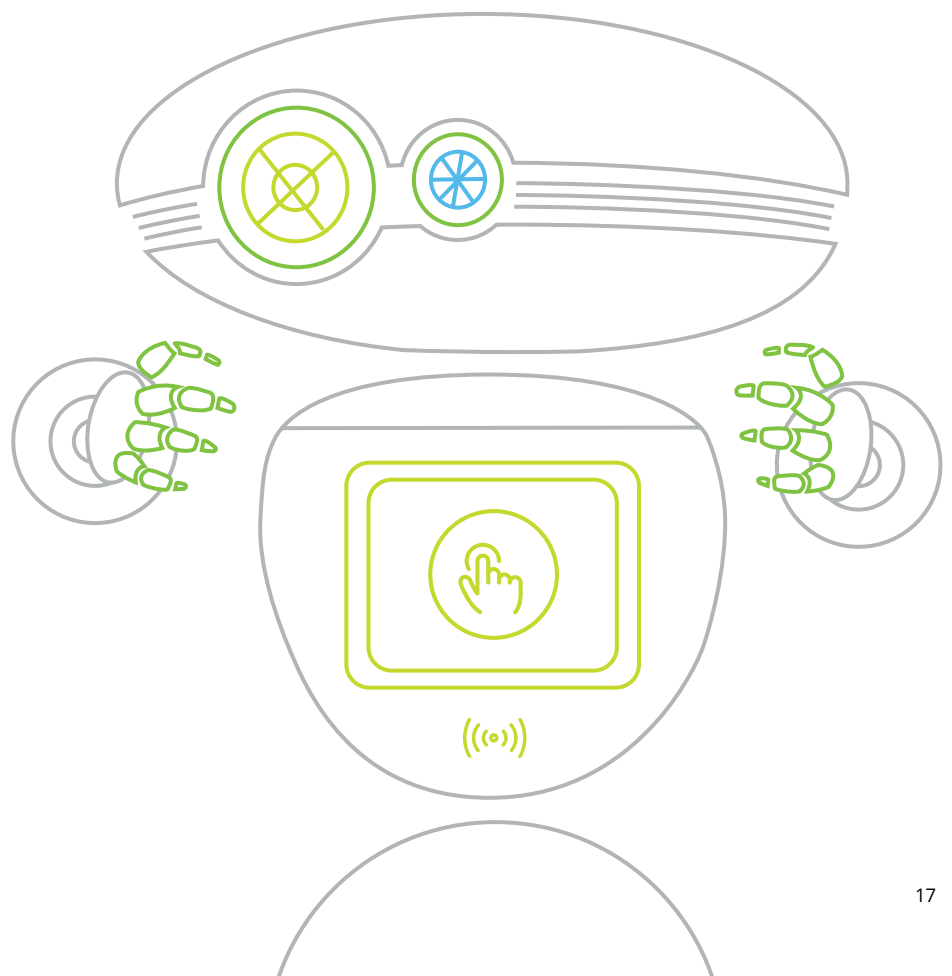

<sup>13</sup> Briggs, B. & Hodgetts, C. (2017)

<sup>14</sup> DeNisco, A. (2017)

# The most valuable commodity I know of is information.

**Gordon Gekko, Wall Street**

A third force affecting data privacy is the regulatory environment. Privacy regulation and its application in the technology industry is a highly disputed topic now, and we assume that it will remain relevant. Regulation is not governed by global standards, but rather in scattered regionalism. Apart from telcos, other players such as OTTs or e-commerce companies face severe challenges to attain global scale.

Blockchain technology combines technological development with human desires and the regulation of data privacy. Blockchains disrupt various processes and transactions in all scenarios, and can serve as gatekeepers of reputation and identity, not only to help establish trust but also to exchange assets safely and efficiently, and – perhaps most promisingly – they offer digital contracts.

## Regulation

In the past, the telco industry was a highly regulated environment with only one company or state agency having the monopoly in the markets. Since then, regulation has opened up the market enormously and changed entire business models, e.g. by abolishing roaming fees in Europe. It has also enabled more players to enter the market and set up their businesses as MVNOs (Mobile Virtual Network Operator) or focus on land-line offerings only. The European Union is planning to harmonize the spectrum access conditions which will allow inter-operability across borders and provide telcos with economies of scale, leading to a more efficient use of the spectrum.<sup>15</sup> US wireless legislation and regulatory policy focused on enabling carriers to obtain national scale by allowing market consolidation. The new European legislation will stimulate market consolidation in the short term, as there are now more than 40 facility-based players in Europe, compared to four carriers in the USA that offer their services nationwide.<sup>16</sup> Regulation will have a

major effect on telcos in all scenarios and in various dimensions, since levies and taxes or other public subsidies could finance the network. Another factor with a major impact will be the payment of fees for mobile spectrum licenses.

## Back to a fixed net world

By the year 2030, 5G, the next mobile telecommunications standard, will be at maturity. However, it will not be a purely mobile standard, but rather a networked convergence of wireless (based on 5G, Wi-Fi and LTE) and fixed networks, involving software-defined networking and network function virtualization. Due to the vast amounts of data that will arise from machine-to-machine communication and to satisfy the capacity demands of industry and end users, a fiber backbone is inevitable. A more granular fiber network will be required down to the last mile to make short latencies possible, thus providing opportunities in the wholesale business to its owners. Yet the demand for a fiber infrastructure as a strategic control point provides the incumbents with strong competitive advantages, as they already possess this infrastructure and can use it to differentiate themselves from the competition.

**Fig. 4 – Competitive revenue and member per employee comparison**

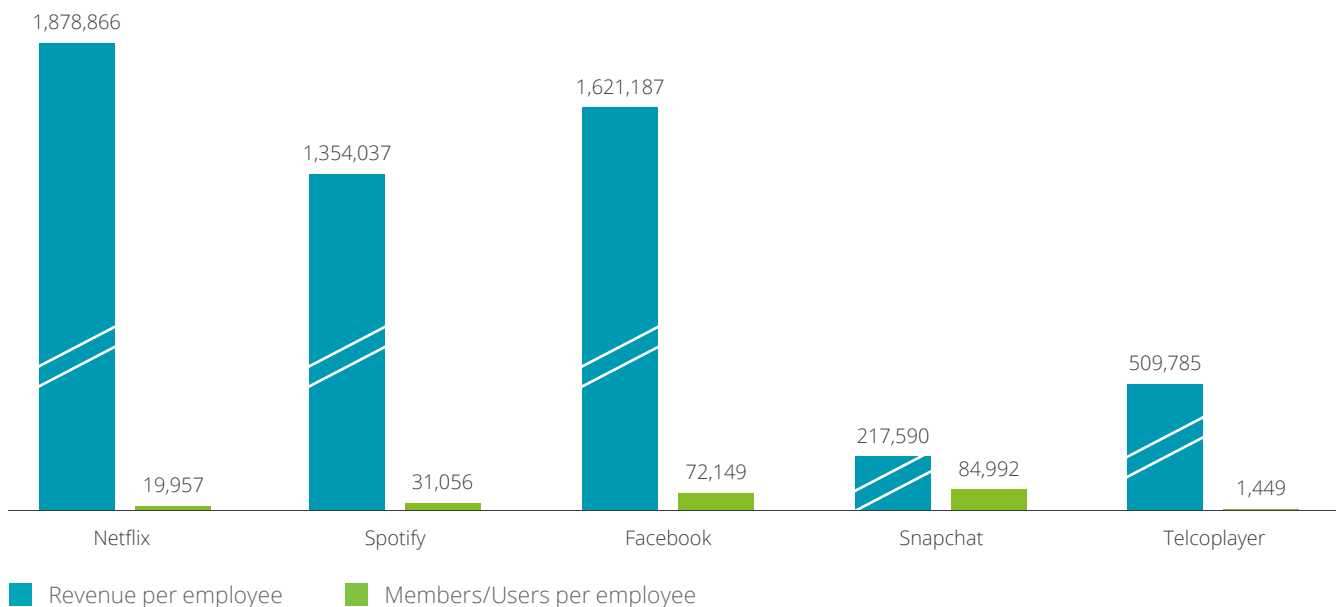

### Smart analytics and process automation

While in today's business environment the analytics capacities of telcos are highly dependent on manpower, in 2030 analytics will be highly automated, driven by cheap computing power and advanced algorithms. This is made possible by Artificial Intelligence capabilities, machine learning, cognitive analytics, robotics process automation (RPA), and bots that can take over tasks that today require human intelligence. When these tools are interconnected, they can boost employee productivity, automate increasingly complicated workloads, and establish cognitive 'assistants' which mimic human thinking and engagement. These machine intelligence systems can make inferences and predictions and take the cognitive insights they generate, transfer them into actionable plans, and finally process them, enabling companies to detect key patterns and relationships from billions of data sources in real-time to derive deep and actionable insights about their customers and the network.

At the same time as becoming leaner, telcos are required to tap into new data sources for analysis. Today, companies only analyze a minor portion of the available data. Estimates show that by 2020, 37% of the digital environment will consist of valuable information once it is analyzed; consequently, companies that tap into all relevant sources and analyze them sufficiently can achieve more than USD 430 billion worldwide in productivity gains in comparison to their peers who do not leverage this data.<sup>15</sup> Based on their ability to analyze a full set of data, telcos can validate or formulate their expectations, advise decision-making, and formulate future strategies.

Fig. 5 – Digital transformation and scaling

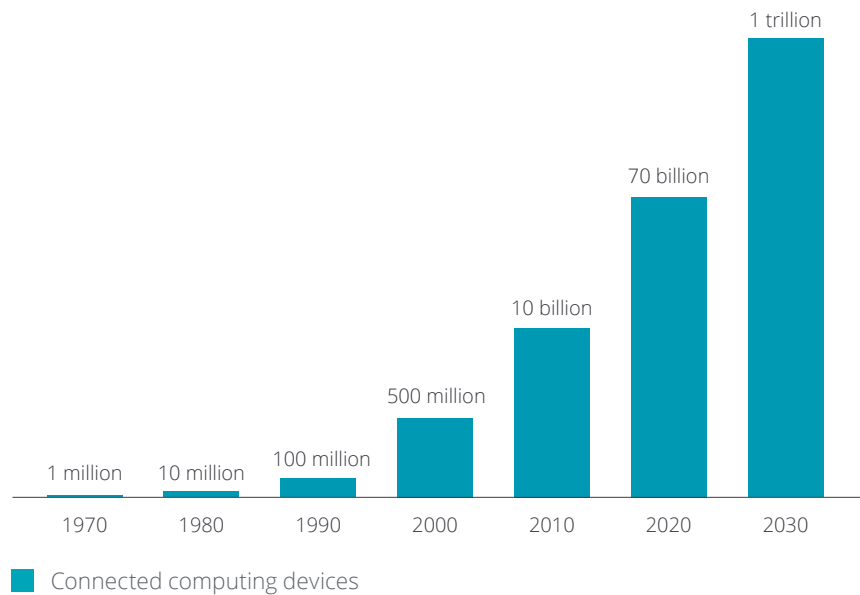

Sources: Deloitte

### Leadership and talent

Management processes will change radically in all scenarios: not only will the development and use cycles for products become shorter at exponential speed, but also decision-making cycles will change at a rapid pace, leading to agile management methods to stay innovative and relevant in an ever-changing market environment.

Across all scenarios, telcos will have outsourced most non-core activities that they still conduct in-house at present. Operational excellence will enable telcos in 2030 to capitalize on big data to be more efficient in the network and the customer base, e.g. by lowering the costs of customer acquisition and retention and network maintenance. Despite technological progress, the workforce will still be a key resource for telcos. All companies, regardless of sector, will be looking for people who have the mindset and the ability to

drive innovation. In view of the shortage of highly skilled technology experts and data analysts that we are likely to face in 2030, telcos need to invest in employer branding to remain an attractive employer when expanding their workforce. In the case of downsizing, retention strategies for key staff are vital. The key to success will be a new set of skills such as engineering, software, and analytics that enable employees to master new technologies and innovative business models, yet such skillsets are rare. Telcos therefore need to adapt their HR approach to attract the profiles needed.

In addition, the general workforce will need to be more flexible and agile. Only the core workforce, consisting of top decision-makers and highly skilled risk-takers who would otherwise not join the company, should be employed permanently. All other areas of the workforce will be staffed on demand on a pay-per-project basis.

<sup>15</sup> European Commission (2016)

<sup>16</sup> Brake, D. (2015)

<sup>17</sup> Briggs, B. & Hodgetts, C. (2017)

# Journey into our four scenarios



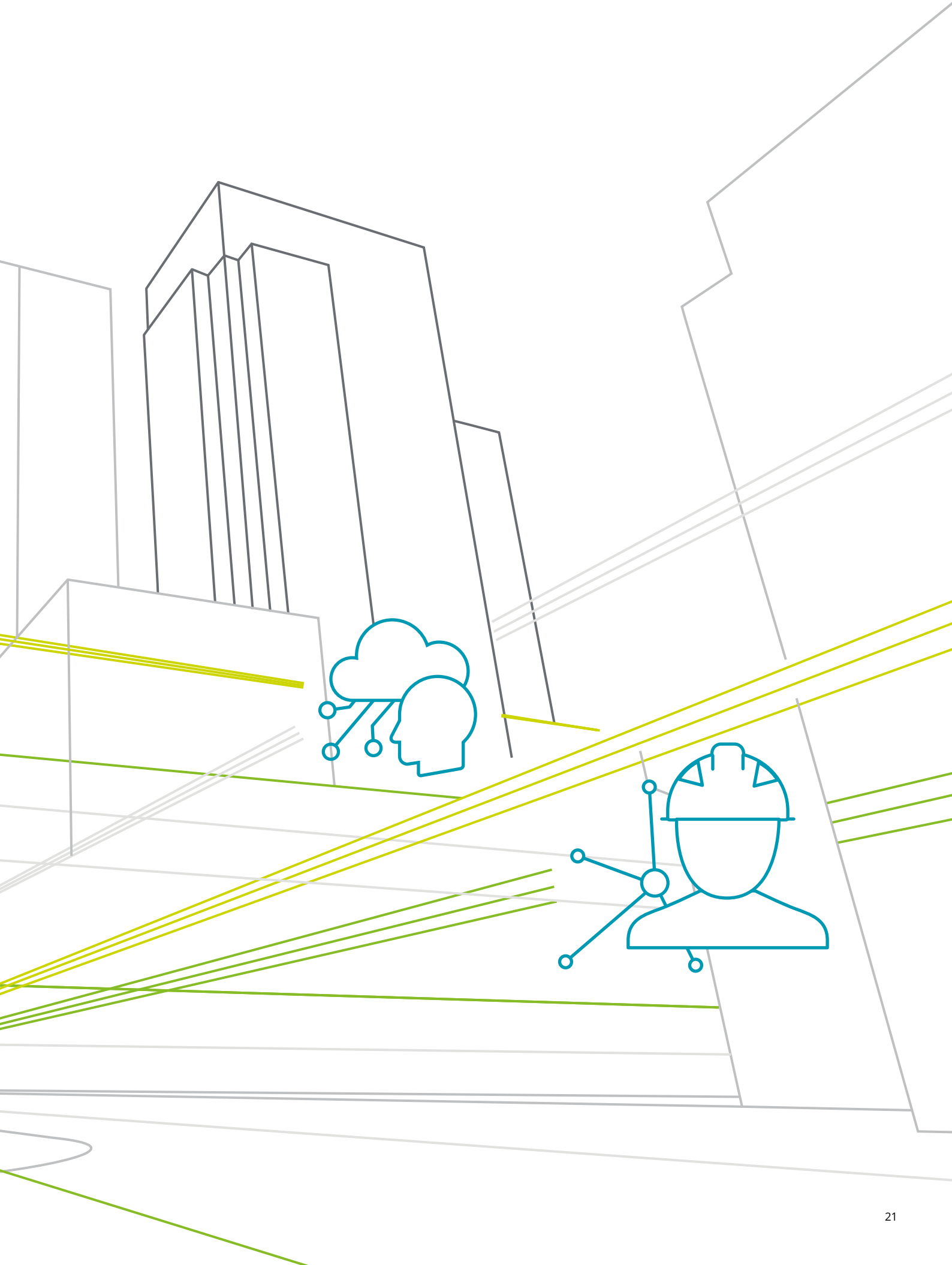

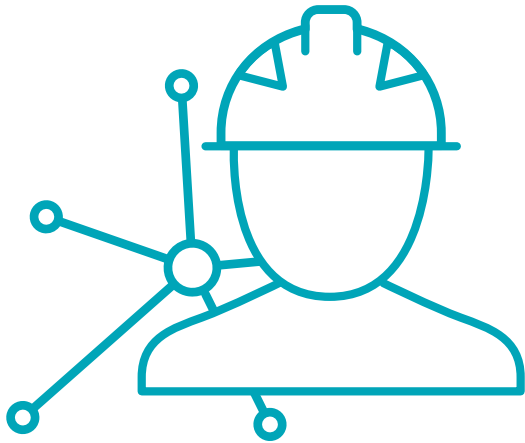

## Scenario 1: The engineer strikes back

In “The engineer strikes back”, telco companies own the network technology domain and infrastructure as well as the customer relationship. This is where telcos come from and where they hope to end up. They drive network innovation with their technological competence and have the ability to maintain and operate their assets. The telco players furthermore master the customer relationship and can thus focus on the whole value chain. They own the revenue control points, having direct access to their B2B and B2C customers.

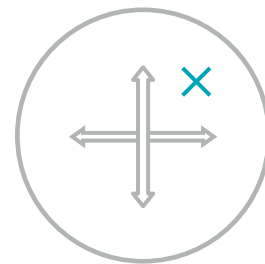

### Network / technology

The telcos' operating model is highly dependent on innovation cycles and on leveraging the latest technology for customers' high bandwidth and short latency demands. Governmental regulation has favored national players taking over the network, as multinational hardware vendors have been reduced to being mere hardware suppliers with limited power in the value chain. The telcos orchestrate the cell mesh network structure which they only partly own. This is built on their own mobile networks and also a large number of 'private' and public wireless networks that are built on a granular fiber backbone. While owning large parts of the value chain, telcos rely heavily on network analytics to improve their general operations. The network providers operate in an oligopolistic market environment. Global telco alliances and partnerships drive global communications and infrastructure standards that are present in the market.

### Customer relations

More than a third of the population belongs to a digital native generation that does not understand the concept of pay-per-minute offerings; rather, they see communications and basic connectivity as basic needs to be financed by a tax such as a network levy. Customers are very willing to pay for fast bandwidth, superior network quality, and a premium customer experience offered by telco players going beyond free, basic connectivity. Display communications have been replaced by conversational communications like hologram technology, communication lenses, built-in devices, or ultrasonic communications. All aspects of life have been changed by intelligent technologies, such as cognitive computing, which make life easier and shape human interaction. Even though digitalization is fully a part of daily life, device producers have a weak relationship with end users, since telcos own the relationship and directly provide value-added services to customers. This is facilitated by other tech players such as OTT players, who remain in their traditional domains. With changes in the regulatory environment, the use and analysis of user-specific data is now widely possible.

Telcos have developed platforms connecting users' devices and providing the necessary connectivity, so they are the intermediary in the market. OTTs and tech players rely on access to these platforms to interact with customers. Consequently, all end-user hardware devices made by various manufacturers are fully connected via the telcos' platforms. Using a Swedish smart home system with a Chinese mobile phone to play Arabic music on American audio equipment does not cause any complications. This decouples hardware companies and OTTs from their customer relationships.

Telcos enjoy high loyalty on the part of their customers, who consequently bear high costs for switching their communications provider.

### Business model

In this scenario, a new generation of hands-on, cutting-edge, software-based network engineers enable innovative revenue generation. Telcos offer services that penetrate and connect different aspects of people's lives by providing individual, tech-based services that are tailor-made to meet the requirements of their B2B and B2C customers. End-user products can leverage optimized network utilization with special deal propositions that depend on user location and use time and thus boost the profitability of their business. Telcos also need strong customer segmentation to offer perfect price differentiation and benefit from individual users' willingness to pay.

To further increase attractiveness for shareholders, highly profitable business can be generated from OTT payments for premium connectivity to end users. Due to their strong position as network owners, telcos can be highly selective in their choice of OTT partner. The combination of sovereignty over network technology, software, and innovation cycles provides telco players with stronger bargaining power over OTT providers than they have seen for a long time.

For network infrastructure elements, the telcos have a good bargaining position with the hardware vendors. By managing third party networks telcos can generate additional income streams from small providers such as municipal utility providers.

Furthermore, telcos initiate their own alliances with their partners of choice to integrate their offerings and market individualized products and services to their customers on their own platforms. The success of the platforms depends heavily on the telcos' ability to secure and interpret user data, which enables them to analyze customer needs and monetize the data. While acting as a broker between OTTs and customers, the telcos also lock consumers into their own ecosystem; as they are in a position to analyze customer data at every

stage in the value chain they have a key competitive advantage. Telcos use their knowledge of customer demand to tailor their product portfolio and bandwidth expansion roadmap.

With their platforms developed in-house, telcos can orchestrate an ecosystem of external and self-built offerings. In the end-user, B2C environment, the telcos have to offer total connectivity across devices and multiple services. They can seamlessly embed different smart home systems into their world and connect it with third party applications such as health or mobility systems. For B2B customers, telcos will be the single network enablers for all IoT solutions that require connectivity. This will be highly relevant in a market that is already exponentially growing from 12.1 billion installed IoT units two years ago to 30.3 billion units in the near future, making it a USD 3 trillion market. Telcos can partner with enterprises who will be users of 60% of all IoT devices.<sup>18</sup>

<sup>18</sup> Vesset, D. & Schubmehl, D (2016)

Client interaction will require advanced data analytics to streamline operations. At the same time the corporate culture requires an entrepreneurial, change-driven mindset as telcos are in direct competition with innovative OTTs, incumbents and startups.

#### **Operational excellence**

Since customers see connectivity as a low-cost, low-involvement commodity and a basic need, telcos must streamline their processes to cut costs and become leaner, which will change operations significantly.

Client interaction requires advanced analytical capabilities to offer in-depth knowledge of customer needs. This is generated through near-perfect segmentation based on personalized insights, predictive analytics, and pattern recognition. Most basic customer-facing processes are fully automated using AI-based tools, which permit them to anticipate customer needs and wishes. In the rare cases in which these algorithm-based services cannot find a solution, telcos run call centers staffed by humans to provide a first-class customer experience to premium customers. These call centers make premium positioning possible for the top ten per cent of paying customers in order to monetize their greater willingness to pay.

Software-defined networking and self-organizing network assets rely on highly automated and predictive network analytics for all purposes such as incident handling, maintenance, and network expansion. The softwareization of networks will bring automation and AI into the hardware technology layer and automate processes that currently require major human interaction, such

as capacity planning or product design. By 2030 there will be few telco processes that cannot be automated with AI-enabled tools. The virtualization of the network results in very lean and automated operations that enable a never-before-seen efficiency. As the telcos have ownership of the network, they need to hire and upskill talent such as software developers, network technicians and engineers. Physical network expansion is fully outsourced to construction and field service partners.

Global telco alliances are a key differentiator for telcos in this scenario. On the one hand, they have to develop new global standards together with other global telco operators to keep non-telco players under control. On the other, they can boost their efficiency by sharing network assets or operational capabilities such as network monitoring centers, giving them scope for OPEX and CAPEX reductions. These deals are a valid alternative to market consolidation to reach global scale. Thirdly, telcos build alliances with partners from other industries such as entertainment, banking, or smart home, to include partners' offerings in their self-developed services.

Even though telcos are highly automated, they are still in need of talent with a fundamentally different skillset (such as software and analytics skills) to manage network and clients. As they are in fierce competition for

talent, especially for technology experts, with players from a vast range of industries, the telcos rely on strong employer branding and attractive salary packages to gain and retain their talent.

Due to the strong demand for innovation, they need to have strong R&D initiatives with a short time-to-market in order to fill customer demand gaps with new services and products. This requires an entrepreneurial, change-driven corporate culture as telcos are in direct competition with innovative OTT incumbents and new startups. Lobbying is a key enabler for telco players to steer political decision-makers into a favorable direction. They are consequently developing and extending their lobbying capabilities.



## Investment

In this scenario, telcos need to invest in various directions. Firstly, they need to expand their network to a great extent – a major investment. Once connectivity has gained the status of a universal basic need, a constant cash flow on a low profitability basis coming from network levies could fund telcos' standard network investment and maintenance needs. The mesh-up network requires a strong granular fiber backbone. According to Deloitte Research, connected mobility will require network latency of around 1 millisecond (compared to today's 50 milliseconds for 4G) for some applications.<sup>19</sup>

Due to the extensive analytical skills, this expansion is demand-oriented in terms of capacity expansion for mobile and fixed networks, as well as new fixed networks for urban development areas. The telco platforms require heavy investment in marketing and programming skills to develop a user-friendly environment, or those could also be acquired from external tech companies and OTT providers.

M&A activities enable them to carry their in-house skills into the new age of software-ization and drive network-focused innovation based on self-organizing networks and new technologies and standards. They are therefore buying tech companies with IT, software, and network capabilities. These skills enable the telcos to invent, build, and maintain the future network.

Research and development capabilities require heavy investment to be at the leading edge in network innovation, in technology and in setting new industry standards.

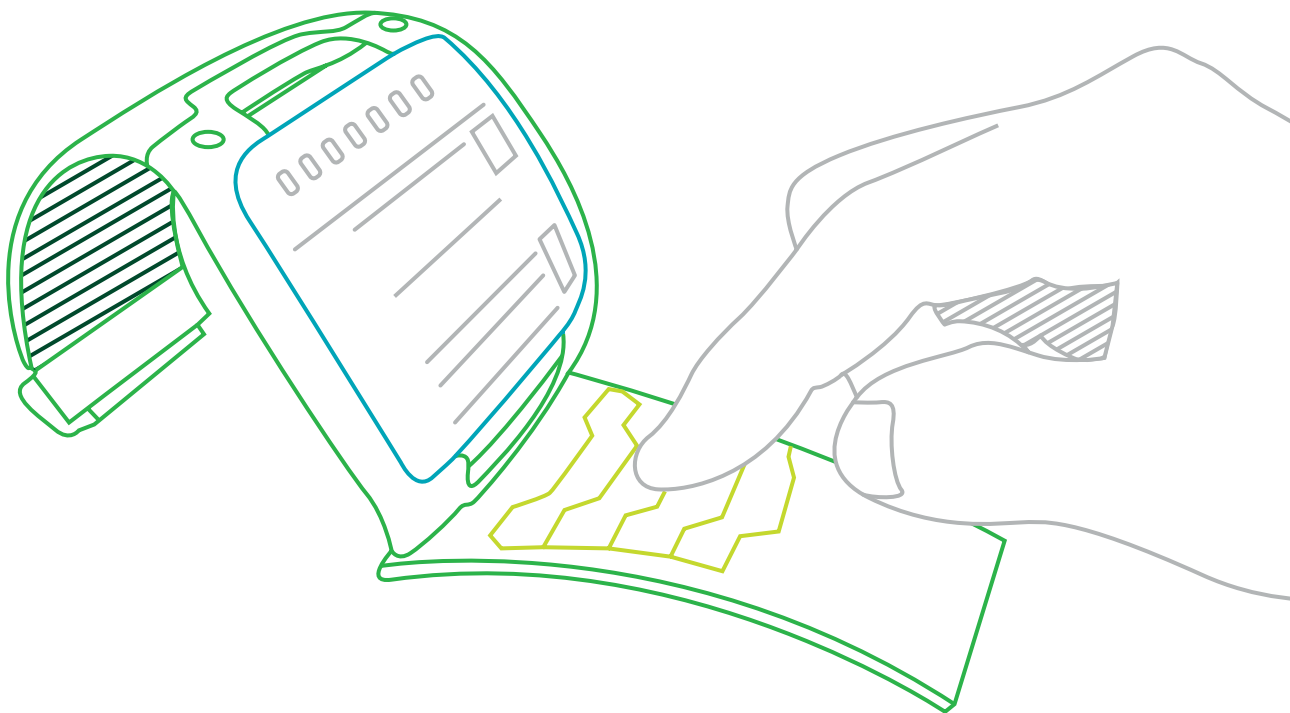

<sup>19</sup> Smud, D.; Wigginton, C. Ninan, S. Ramachandran, K., Mocerri, P. (2017)

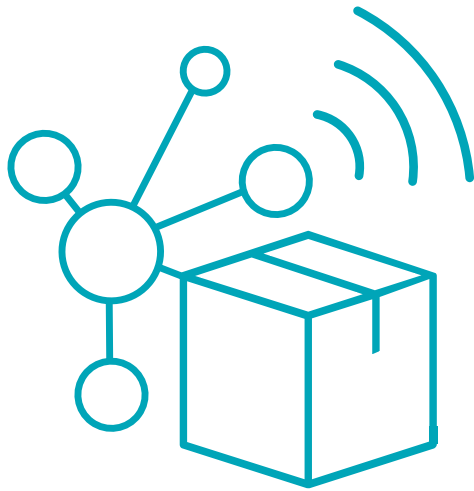

## Scenario 2: The new wholesale truth

In the scenario “The new wholesale truth”, telco companies have finally lost the end-user control points they cherished for so long. To remain relevant, telcos have gone back to taking over full control over the network technology where they still have their core competencies.

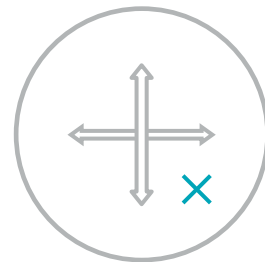

### Network / technology

The telcos are focusing on fixed and mobile network infrastructure, so they have installed cutting-edge fixed broadband, 5G networks or both technologies that are central to the orchestration of network mesh-ups. Telcos are the only source of innovation for new mobile and fixed broadband infrastructure-based services; however, this expansion is very capital-intensive and therefore limited by the telcos’ ability to refinance their investment. Global telco alliances push new standards, shape the industry landscape, and facilitate partnerships.

Telcos own and orchestrate the technological part of the value chain and form the intermediary between vendors and OTTs, who own the end-user relationships.

### Customer relations

End-user devices are separated from the network and enable easy switching of network operators with soft SIM technologies. OTTs and device producers have taken advantage of alliances to disrupt the market, which has enabled them to take over the customer relationship. Initially seen as a gift, telcos opened up their customer data to OTTs, enabling them to completely take over the customer relationships that telcos had maintained and invested in for so long. OTTs now collect and process customer data to enhance the customer experience, an advantage telcos cannot compete against. The OTTs' abundant data is a unique competitive advantage that can be intensified with data from third parties which OTTs can acquire on the market. OTTs leverage this data to enhance customer service with a low headcount, thanks to Artificial Intelligence. However, their network competencies make third-party connectivity revenues for telco companies possible. Customers display strong demand for fast bandwidth and short latencies to connect to their OTT services and consume their multiple digital offerings.

Traditional unbundled services are gone, a multitude of connected devices are operated in each home, family, and company. Apart from the customer-facing OTTs, device manufacturers and tech companies own the end-user control points, since their devices are interoperable, connected, and consequently make life easier for users.

Generally, connectivity is a low-value commodity whereby the end-user segment offers very low margins to all players engaged in basic connectivity. Every citizen has the right to a 100 MBit connection at home, which is financed with public network levies. Although many customers pay for connected services and superior bandwidth, these cash flows go only indirectly to telcos, as most revenues are generated by large tech companies, device manufacturers, and OTTs. By now, customers can choose to obtain connectivity and a service level either with a device or through a provided service.

As a key economic factor, the government takes an active part by publicly subsidizing the infrastructure and the necessary innovation to connect the entire population with high-speed internet and telco services. This makes telcos the lubricant behind the scenes that keeps the system running, as society and the economy depend on the services they offer.

### Business model

In this scenario, the telco business model needs to be refined to enable them to succeed as a 'smart pipe' provider, since they can only offer wholesale products to OTTs. This development can already be seen, as today's customers spend more time with OTT-developed products such as WhatsApp or Snapchat than with traditional telco services. Microsoft's communication tool Skype already carries more than 25% of all global cross-border call traffic.<sup>20</sup>

Telcos have taken over the role of green-keeper for the publicly funded network. Their main customers are OTTs who lease network capacity to provide services to their end-users. In the buyer's market of network infrastructure, the telcos have a good bargaining position as hardware vendors rely on them, and since they run the publicly-funded network, the telcos benefit from their scale and manage external networks for third parties such as municipal utility providers, charging them for this service.

OTT providers offer opportunities for additional revenues through premium connectivity sold via wholesaling. Having been pushed to the side, telcos focus on developing the 'smart pipes' in "the new wholesale truth"; they have several choices here: they can offer small bundles of data with low discounts and thus higher profitability or larger data-based wholesale packages with high discounts and lower profits. Furthermore, they can wholesale their entire infrastructure with higher margins. As the network owners, the telcos are an enabling partner of IoT firms, providing connectivity for manufacturers to connect their machines and systems.

Since the various telco players face a similar situation, combining their forces in alliances is a way to stay at the forefront of network technology.

<sup>20</sup> Forge, S. (2015)

### Operational excellence

To run this business model successfully, the organizational set-up needs major changes. Telcos will have to transition into highly efficient, fully automated utility providers with very lean structures. The telco players own large parts of the network value chain and rely heavily on network analytics to improve their general operations and thus boost their revenues. Processes and predictive network analytics have become essential for software-defined and self-organizing networks to optimize operations such as incident management or maintenance. The softwareization of networks will also bring RPA into the hardware technology layer and automate processes that currently require major human interaction, such as capacity planning and product design. However, the telcos focus on technological service for their wholesaling partners. Physical network expansion as well as network operation and maintenance are fully outsourced to construction and field-service partners.

Telco alliances develop new global industry standards that amplify the telcos' prime position in network innovation. Thanks to their alliances, telcos can combine their assets via network sharing to split investment and maintenance costs.

On the FTE side, telcos are reducing their overheads significantly. Due to the loss of customer interaction, almost all employees in customer-facing areas have become redundant. Most marketing and sales capabilities have been abolished, only a few key account managers and analysts for large customers such as OTTs remain in the company. Apart from back-office capabilities, the workforce mainly consists of engineers and technology experts. However, to get access to this group of highly skilled people who are sought-after by various other players, telcos need to develop best-practice approaches to attract and retain talent.

As network levies are an essential element of funding network maintenance and expansion, telcos need to direct political decision makers and therefore need strong lobbying capabilities.

### Investment

In this world, telcos need to invest in two dimensions. First, they need to expand their network, where public funding is a strong lever. To be able to control the network, telcos have to invest in IT and software capabilities to design, build, and run future networks. Capabilities can be built in-house or may be acquired from competitors and tech companies. Second, research and development capabilities require heavy investment in order to be at the leading edge in network innovation in technology and in setting new industry standards.

Hope is being able  
to see that there is  
light despite all of the  
darkness.

**Desmond Tutu**



## Scenario 3: The virtual telco

In the scenario “The virtual telco”, telcos remain the primary customer relationship holders but are displaced from the network layer as they transfer tech domain sovereignty fully to vendors and other players who move into the network by becoming new infrastructure players.

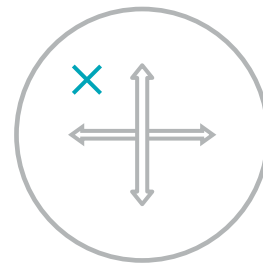

### Network / technology

The network landscape is highly consolidated. The infrastructure landscape is dominated by a large, vendor-driven network. With their technology competencies, vendors drive the ongoing network innovation based on SDN and NFV. The large global vendors integrate the latest technologies and drive first 6G approaches that combine existing 5G capabilities with a satellite infrastructure, enabled through partnerships. Progress is limited as network providers' offerings and end user requirements are decoupled, thus resulting in longer innovation cycles, so vendors push their innovation in the market. Ever-increasing bandwidth requirements are analyzed by vendors who orchestrate technological development.

Vendors not only drive the network infrastructure, but also enable and facilitate IoT development, as they leverage their customer relationships and their network ownership to major tech companies. Telco players own only few parts of the network capabilities which are dominated by large vendors, and can consequently only compete with these strong forces in global development with difficulty.

### Customer relations

Consumers' lives are 'smart' and intelligent across multiple connected devices; telcos provide their customers with innovative – largely network-agnostic – services from the Cloud. Even though digitalization is fully integrated into daily life in every aspect of human interaction, device producers have a weak relationship with end-users. Since connectivity is a commodity and consumers are decoupled from the network, network quality is no longer a unique selling point any provider can benefit from. Regulatory changes enable new data analytics methods and facilitate the use of customer data. Clients interact on automated customer care platforms via chatbots and self-care facilities with AI-enabled service offerings from their telco provider. Telcos are thus enabled to provide their customers with any information at any time via self-service offerings. Customer service is a key differentiator in the overall customer experience. Furthermore, in case of interaction with human customer services representatives, AI can provide all relevant information to solve issues that go beyond the scope of the self-service platforms. Telcos use their understanding of customer demands to approach clients on the most appropriate channel and supply them with innovative, tailored products.

### Business model

This scenario requires a business model with tailor-made, individual products which meet customers' requirements and which must display a high level of flexibility. Customers demand innovative pricing concepts outside the classic minute-based plans that easily facilitate data sharing and enable all the benefits of connected living. To service all the different levels of willingness to pay, strong customer segmentation for perfect price differentiation will be necessary. As all clients have different payment preferences, telcos offer hybrid pricing models that combine pre- and postpaid models with different payment forms. This is based on the telcos' ownership of user data, which enables them to analyze customer needs and monetize user data.

Telcos do not run their own network any longer but rather use rent and lease models from the vendors who run the network cost-efficiently; many brands lease network capacity for their customers and operate as mobile virtual network operators who supply the entire ecosystem with connectivity. Their optimized services enable high performance across all available infrastructures. Freed from their infrastructure base, telcos are aiming for pan-European or even global scale with their purely cloud-based services that enable them to take advantage of economies of scale by operating in a single European market.

Other players are beginning to offer communications services over the networks in competition with the telcos. Having shed their network responsibilities, telcos directly engage in customer sales and also fulfill their role as an intermediary between OTTs, tech-companies, and other players on the one hand and customers on the other, by offering open platforms that connect different devices and services. As virtual operators, telcos have their own platform environment in which they can easily integrate offerings from their various partners with a variety of services such as banking, media, or smart home connectivity. These cloud-based platforms are open for external developers to increase attractiveness

for users to join and stay in these ecosystems. Telcos initiate agile development capabilities to be able to fulfill customers' demands that are not yet served by partner offerings. Partners join this ecosystem and incentivize telcos with commissions to push their specific offerings and hence provide a new and significant source of income. These commissions are flexible, depending on the importance of the service to customers, and varies by customer segment. Telcos are therefore taking on a broker role for B2B and B2C customers, which makes them the central point of communications, orchestrating the customer relationship, which brings benefits to both customers and third party service providers.

### Operational excellence

This business model requires a new operational excellence environment. As the telcos are no longer in charge of the network, all network operations have been handed over to partners. In order to stay relevant in this communications commodity market, data analytics are inevitable for the telcos. Cognitive and conversational computing as well as analytics-based and optimized processes are needed to remain relevant and succeed in the market with improved, efficient customer services. The telcos therefore require a high level of customer knowledge which is enabled by Big Data and analytical capabilities, leading to a world-class AI-enabled customer service. They generate this through nearly perfect segmentation based on personalized insights, predictive analytics, and pattern recognition. The telcos steer their customers' connectivity by switching between networks according to time, place, capacity, and use case.

Telcos can thus significantly reduce the number of client-facing service agents; nevertheless, customer service is often outsourced to third-party providers who can offer leading-edge solutions. The telcos are in a customer-facing position and obtain insights into network issues, but detailed problem analysis and troubleshooting are conducted by network operators.

In order to source the required network capacities, the telcos need predictive procurement to offer their customers time- and location-specific services with high efficiency. The headcount will be reduced, especially in IT and network technology, as these functions are no longer needed. At the same time the marketing and sales departments will be transformed. There is demand for customer relationship managers and data scientists to understand existing clients better; these analytic capabilities also facilitate addressing prospects. For innovative product developments, telcos need an agile culture that accepts failure with a fail-fast approach to generating constant, IP-based, incremental innovation.

**Investment**

Since they use the network under a leasing model, telcos are freed from investing here. The sale of their existing assets will initiate an inflow of funds, which they can use either to fund future investment or to distribute to shareholders. To stay relevant and attract customers, telcos need to enlarge their product development, marketing, and customer service capabilities by investing; they also need agile trend-sensing to quickly acquire upcoming trends with their M&A machine.

We see our customers as invited guests to a party and we are the hosts. It's our job every day to make every important aspect of the customer experience a little better.

Jeff Bezos

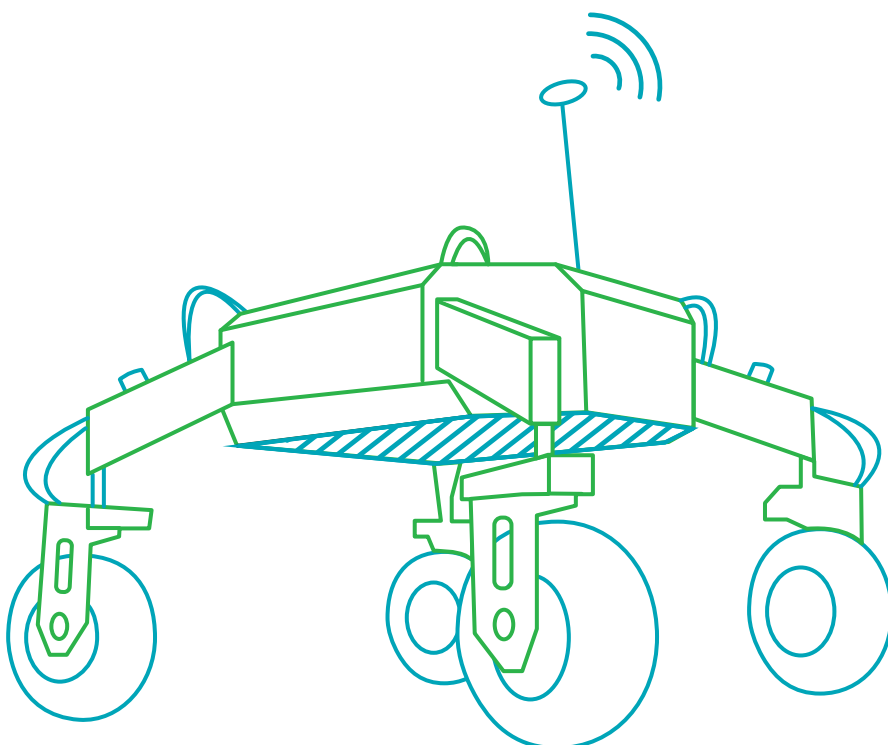

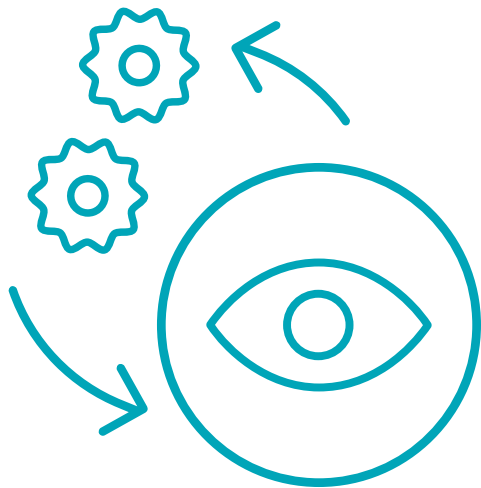

## Scenario 4: A vendor brand

In the scenario “A vendor brand”, telco players have been driven out of both domains, customer relationships and technological mastery. They focus on their few remaining capabilities, trying to find their sweet spot in the market to maintain their relevance. Telcos are mere ghosts of their former selves, and serve as the wholesale sales and service teams of their parent tech companies for B2B customers.

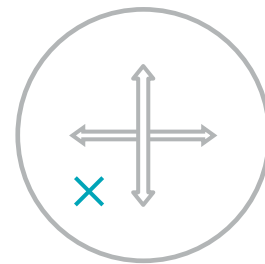

### Network / technology

The consolidated European communications market is harmonized. Outsourcing plus the introduction and exponential growth of IoT have enabled large network and technology players to enter the market, taking control of the networks by acquiring technology and network capabilities from telco companies. They have developed further IT and software capabilities to design, build, and maintain future networks based on SDN and NFV. With 5G at its peak deployment and 6G in the process of introduction, a large number of private networks have created a high-performance mesh network, built on the back of a vendor-deployed highly granular fiber core infrastructure which vendors also run and maintain. While the vendors have taken over the networks, telcos have lost their network competencies altogether.



### Customer relations

Customers see connectivity as merely another utility, although apps and value-adding service in connection with flexible connectivity products are important to their digital lives, with seamless connectivity across multiple devices in the background. However, as private data are protected by strict laws across Europe, telcos and their parent companies are limited in their use of personalized data. Customer contact is owned and controlled by OTT players and device manufacturers, who can leverage this control by providing innovative products and services in the market. Vendors not only drive the network infrastructure, but are also at the heart of IoT developments, as they utilize their customer relationships and network ownership to major tech companies. Over time they integrate vertically in IoT, Automotive and e-health.

### Business model

This scenario, in which telcos are no longer in charge of the network or the client, has major consequences for the business model. Those telco companies who are still in the market belong to large companies and are merely a sales division with a strong brand name. The raison d'être of the telcos is their in-depth sales competence with a high level of customer understanding. The majority of the telco workforce consists of flexible, contracted workers to cope with the volatile marketplace.

Most B2C revenues end up with OTTs and the network owner parents of the telcos, so the telcos can only focus on their parent companies' B2B customers, to whom they offer individual solutions. The technological environment of the telcos is an open API world. They have to leverage the capabilities and offerings of their parent company for all their services.

### Operational excellence

The harmonized market enables telcos to operate with their small vertical service and sales teams from a few European hubs. The majority of the staff consists of key account managers for the top B2B accounts that generate most of the revenues. All other business processes are outsourced to external service providers or the parent company. Ever-increasing bandwidth requirements are analyzed and technological development is orchestrated by the parent companies of the telcos – the vendors. The telcos have used insolvency cases to free up personnel capacities and terminate other unwanted contractual relations.

### Investment

The telcos have limited investment capabilities that they use to sustain their brand, which still has a high brand awareness based on past end-customer interaction. Maintaining brand equity is therefore a key challenge, even though they only act as a sub-brand. In this scenario, telcos are not investing in network infrastructure, while investments in customers are very limited to the few B2B customers they handle. Other infrastructure is provided by their parent companies and thus requires no investment by the telcos themselves.

# Taking the long view

American management author John C. Maxwell said “Change is inevitable. Growth is optional”. However, for telcos, it is not only growth that is called into question, based on current trends taking place but also the entire business model.

To grow, and even more importantly, to survive, telcos need to define for themselves which role they want to occupy.

Do they want to be the holder of the network infrastructure and customer relationships at the same time or would they rather focus on one of those two domains in order to maximize shareholder value?

Having developed their future aspiration and identity, telcos need to define which business model helps to monetize this idea best. This requires companies to shape their operational excellence and allocate their investments to enable success.

Despite all these questions, there are some ‘no regret’ moves telcos can easily execute:

Continuously participate in regulatory discussion by active lobbying since connectivity will be seen as a low-involvement commodity in future

Develop virtual platforms that are open to external developers and partners as well as implement new and innovative offerings

Strengthen their position as appealing employer, while updating the required skillset of their workforce in an ongoing process to attract and retain the best talent in the market

Adapt the latest AI-based technology to automate as many tasks as possible, significantly reducing operating costs in the medium to long term

So now it's the telcos' job to decide where they place their priorities – and which bets they are willing to take!

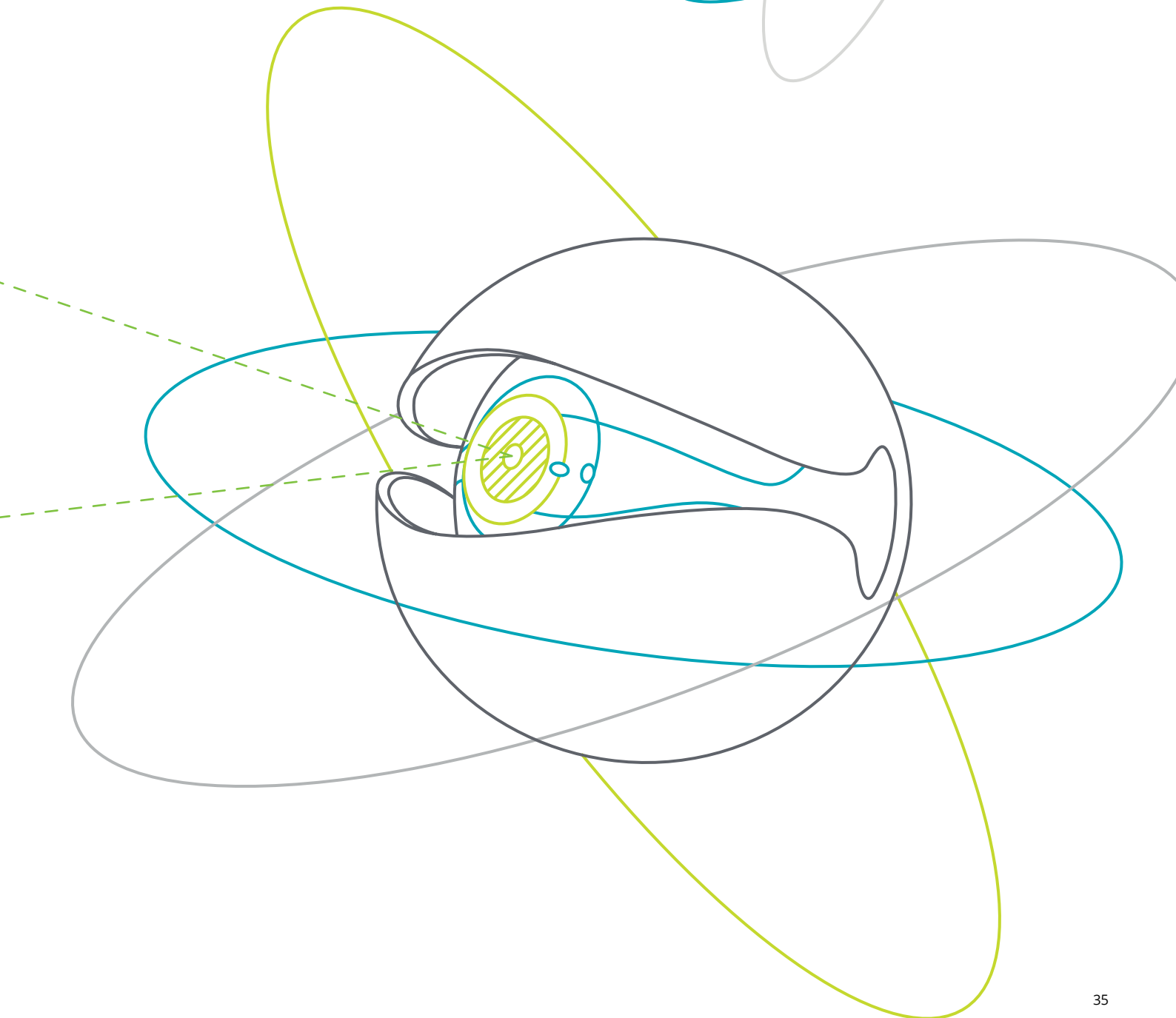
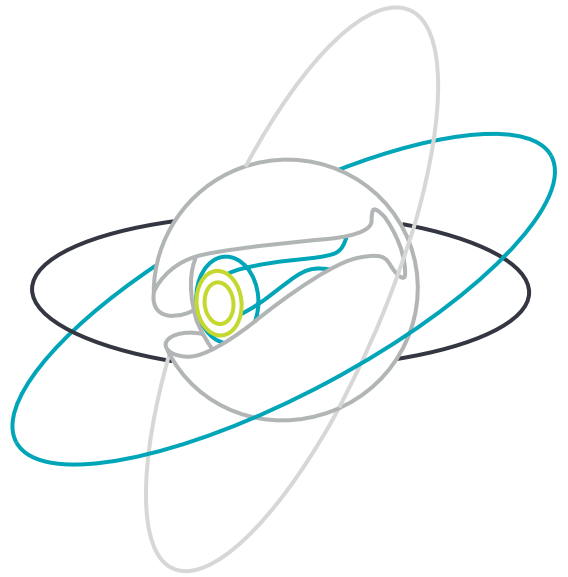

# Sources

Böhm, K. (2015). Ständig auf Empfang. Neue Nutzungsmuster bei deutschen Smartphone-Usern. Deloitte.

Bohn, D. (2016). Microsoft has created Star Wars-style holographic communication. The Verge. <http://www.theverge.com/2016/3/26/11309624/microsoft-hololens-holoportation-star-wars>

Brake, D. (2015). Spectrum Policy and the EU Digital Single Market: Lessons from the United States. ITIF. <http://www2.itif.org/2015-eu-spectrum-policy.pdf>

Briggs, B. & Hodgetts, C. (2017). Tech Trends 2017. The kinetic enterprise. Deloitte University Press, [https://dupress.deloitte.com/content/dam/dup-us-en/articles/3468\\_TechTrends2017/DUP\\_TechTrends2017.pdf](https://dupress.deloitte.com/content/dam/dup-us-en/articles/3468_TechTrends2017/DUP_TechTrends2017.pdf)

Cairncross, F. (2001). The death of distance: How the communications revolution is changing our lives. Harvard Business Press.

DeNisco, A. Report: Despite privacy concerns, 43% of consumers offer personal data in exchange for discounts. Tech Republic. <http://www.techrepublic.com/article/report-despite-privacy-concerns-43-of-consumers-offer-personal-data-in-exchange-for-discounts/>

Erdmann, C. (2011). One more thing - Apples Erfolgsgeschichte vom Apple I bis zum iPad (Apple Gadgets und OS).

European Commission (2016). Digital Single Market. <https://ec.europa.eu/digital-single-market/en/what-radio-spectrum-policy>

Forge, S. (2015). The future of global telecommunications in view of the growth of OTT services: expected impacts on usage and prices. ITU

Handelsblatt (2014). Vor 25 Jahren wurde die WWW-Idee geboren. <http://www.handelsblatt.com/technik/vernetzt/world-wide-web-vor-2>

Lutter, T., Meinecke C.-M., Prescher, D., Böhm, K. & Esser, R. (2016). Zukunft der Consumer Technology - 2016. Deloitte/bitkom. [https://www2.deloitte.com/content/dam/Deloitte/de/Documents/technology-media-telecommunications/CT-Studie\\_2016\\_online.pdf](https://www2.deloitte.com/content/dam/Deloitte/de/Documents/technology-media-telecommunications/CT-Studie_2016_online.pdf)

Lozano, A. (n.d.). The Hall of Innovation. <http://www.dtic.upf.edu/~alozano/innovation/>

Meigs, J. (2012). Inside the Future: How PopMech Predicted the Next 110 Years. <http://www.popularmechanics.com/technology/a8562/>

Pillkahn, U. (2013). Pictures of the Future. Zukunftsbetrachtungen im Unternehmensumfeld. In Zukunftsforschung im Praxistest (pp. 41-79). Springer Fachmedien Wiesbaden.

Reichert, C. (2016). 5G requires fiber-based infrastructure. ZDNet. [http://www.zdnet.com/article/5g-requires-fibre-based-infrastructure-nokia/#ftag=RSSbaffb68https://www.theregister.co.uk/2016/06/15/nokia\\_to\\_oz\\_5g\\_will\\_need\\_fibre\\_and\\_lots\\_of\\_it/](http://www.zdnet.com/article/5g-requires-fibre-based-infrastructure-nokia/#ftag=RSSbaffb68https://www.theregister.co.uk/2016/06/15/nokia_to_oz_5g_will_need_fibre_and_lots_of_it/)

Sallomi, P. & Lee, P. (2017). Technology, Media and Telecommunications Predictions 2017. Deloitte. <https://www2.deloitte.com/de/de/pages/technology-media-and-telecommunications/articles/tmt-predictions-2017.html>

Schwartz, P., & Ogilvy, J. (2004). Plotting your scenarios. An introduction to the art and process of scenario planning. Global Business Network.

Smud, D.; Wigginton, C. Ninan, S. Ramachandran, K., Mocer, P. (2017). Connecting the future of mobility. Reimagining the role of telecommunications in the new transportation ecosystem. Deloitte University Press. <https://dupress.deloitte.com/dup-us-en/focus/future-of-mobility/role-of-telecommunications-in-new-mobility-ecosystem.html>

Vesett, D. & Schubmehl, D. (2016). IDC FutureScape: Worldwide big data, business analytics, and cognitive software 2017 predictions. International Data Corporation.

Wigginton, C. (2017). Telecommunications outlook 2017. Deloitte. <https://www2.deloitte.com/us/en/pages/technology-media-and-telecommunications/articles/telecommunications-industry-outlook.html>

Wilkinson, L. (1995). How to Build Scenarios. Planning for "long fuse, big bang" problems in an era of "uncertainty". Wired "Scenarios: The Future of the Future".

Winkelhage, J. (2006). Vom Buch der 99 Narren zum Milliardengeschäft, Frankfurter Allgemeine Zeitung, 12.05.2006, <http://www.faz.net/aktuell/wirtschaft/netzwirtschaft/125-jahre-telefonbuch-vom-buch-der-99-narren-zum-milliardengeschaeft-1329208.html>

# Methodology

The methodology of this study is based on the proven scenario approach first employed by Shell, and then perfected by Monitor Deloitte. A seven-step scenario development approach (see figure 6) applies the guiding scientific principles of objectivity, reliability, and validity. The study is the outcome of a series of interviews, questionnaires, and workshops involving TMT experts from the Deloitte EMEA network and industry professionals as well as experienced scenario practitioners from Monitor Deloitte's Center for the Long View (CLV).

Scenario design starts by identifying the focal question of the underlying issue. Since we could tell an infinite number of different stories about the future of the telco industry, we first had to agree on the issue or strategic challenge we wanted to address. This enabled us to support our telco clients' decision-making in an appropriate way. Scenarios are tools for shedding light on the strategic challenge, while the focal question sets the scope of the scenarios. In the present case, we focused on the question "What will the telco world look like by 2030?"

Scenarios are a way of understanding the dynamics that shape the future. Therefore, in a second step, we pinpointed the forces that drive the focal questions. Driving forces are fundamental sources of future change. They shape the course of events and history and dramatically enhance our ability to imagine future scenarios. These drivers can be grouped into five categories, known as STEEP forces, as they consist of Social, Technological, Economical, Environmental and Political forces. Since most issues involve more than one of these categories, they are only handles. In order to derive our driver list, we also conducted expert workshops using Deep View, an artificial intelligence (AI)-based trend-sensing and analysis machine. Deep View helps to

**Fig. 6 – Center for the Long View Scenario Methodology**

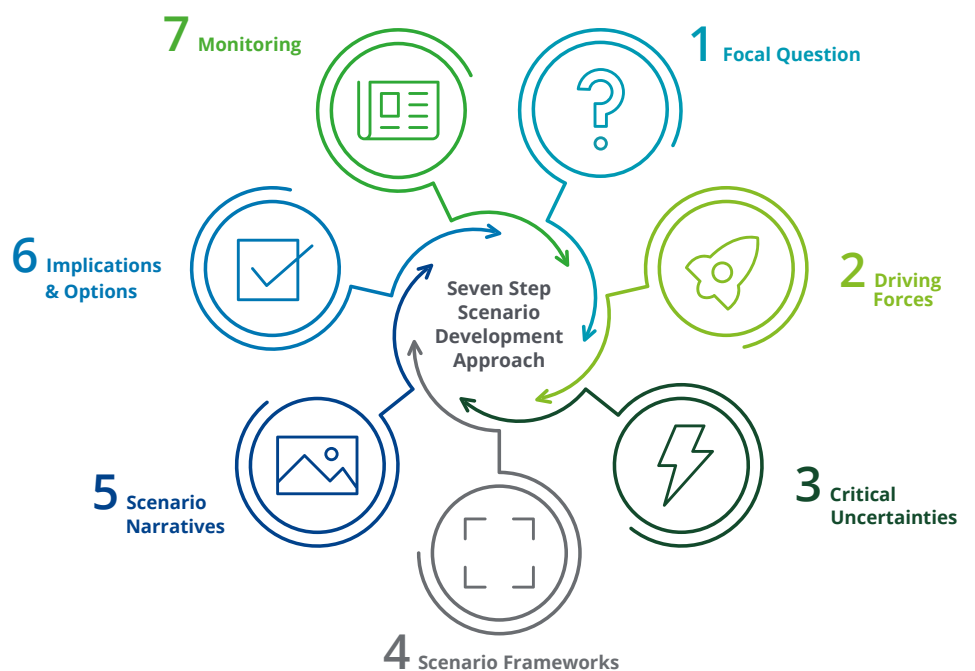

avoid the bias of the traditional approach, which often has a built-in tendency based on the character, mood, or preferences of the scenarists.

As a part of the workshop series, in a third step we identified the critical uncertainties for the focal question. Not all driving forces are uncertain, some may be pre-determined. These are the trends already in the pipeline, unlikely to vary significantly in any of the scenarios. Critical uncertainties are driving forces with the potential to tip the future in one direction or another. They have two fundamental characteristics: they have an unusually high impact and are uncommonly uncertain or volatile. Initially, all uncertainties appear unique, but by stepping back, we can reduce uncertainties to clusters that serve as the building blocks

for creating our scenario sets.

The scenario framework was developed in the next step by focusing the entire list of related uncertainties into two orthogonal axes. We then defined a matrix consisting of crossing and independent axes that allowed us to define four very different, but plausible, quadrants of uncertainty. In the underlying study, we used "Ownership of traditional customer relationship" and "Dominance of the technology layer" as critical uncertainties.

# Contacts



**Alexander Mogg**

Partner  
Technology, Media & Telecommunications  
Monitor Deloitte  
Tel: +49 (0)89 29036 7939  
amogg@deloitte.de



**Tim Bottke**

Partner  
Technology, Media & Telecommunications  
Monitor Deloitte  
Tel: +49 (0)89 29036 8964  
tbottke@deloitte.de



**Dr. Andreas Gentner**

Partner  
Technology, Media & Telecommunications  
Consulting  
Tel: +49 (0)711 16554 7302  
agentner@deloitte.de



**Jaime Rodriguez-Ramos**

Partner  
Technology, Media & Telecommunications  
Monitor Deloitte  
Tel: +34 (0)911 5772 97  
jrodriguezramos@deloitte.es



**Dr. Florian Klein**

Director  
The Center for the Long View  
Monitor Deloitte  
Tel: +49 (0)69 9713 7386  
fklein@deloitte.de



**Sabrina Frühauf**

Manager  
Technology, Media & Telecommunications  
Monitor Deloitte  
Tel: +49 (0)89 29036 2527  
sfruehauf@deloitte.de

**Special thanks to Daniel Glaser and Andreas Schühly for their contribution.**





[www.deloitte.de/de/future-of-telco](http://www.deloitte.de/de/future-of-telco)

# Monitor Deloitte.

Deloitte refers to one or more of Deloitte Touche Tohmatsu Limited, a UK private company limited by guarantee ("DTTL"), its network of member firms, and their related entities. DTTL and each of its member firms are legally separate and independent entities. DTTL (also referred to as "Deloitte Global") does not provide services to clients. Please see [www.deloitte.com/de/ueberUns](http://www.deloitte.com/de/ueberUns) for a more detailed description of DTTL and its member firms.

Deloitte provides audit, risk advisory, tax, financial advisory and consulting services to public and private clients spanning multiple industries; legal advisory services in Germany are provided by Deloitte Legal. With a globally connected network of member firms in more than 150 countries, Deloitte brings world-class capabilities and high-quality service to clients, delivering the insights they need to address their most complex business challenges. Deloitte's more than 244,000 professionals are committed to making an impact that matters.

This communication contains general information only not suitable for addressing the particular circumstances of any individual case and is not intended to be used as a basis for commercial decisions or decisions of any other kind. None of Deloitte Consulting GmbH or Deloitte Touche Tohmatsu Limited, its member firms, or their related entities (collectively, the "Deloitte network") is, by means of this communication, rendering professional advice or services. No entity in the Deloitte network shall be responsible for any loss whatsoever sustained by any person who relies on this communication.