

Deloitte.

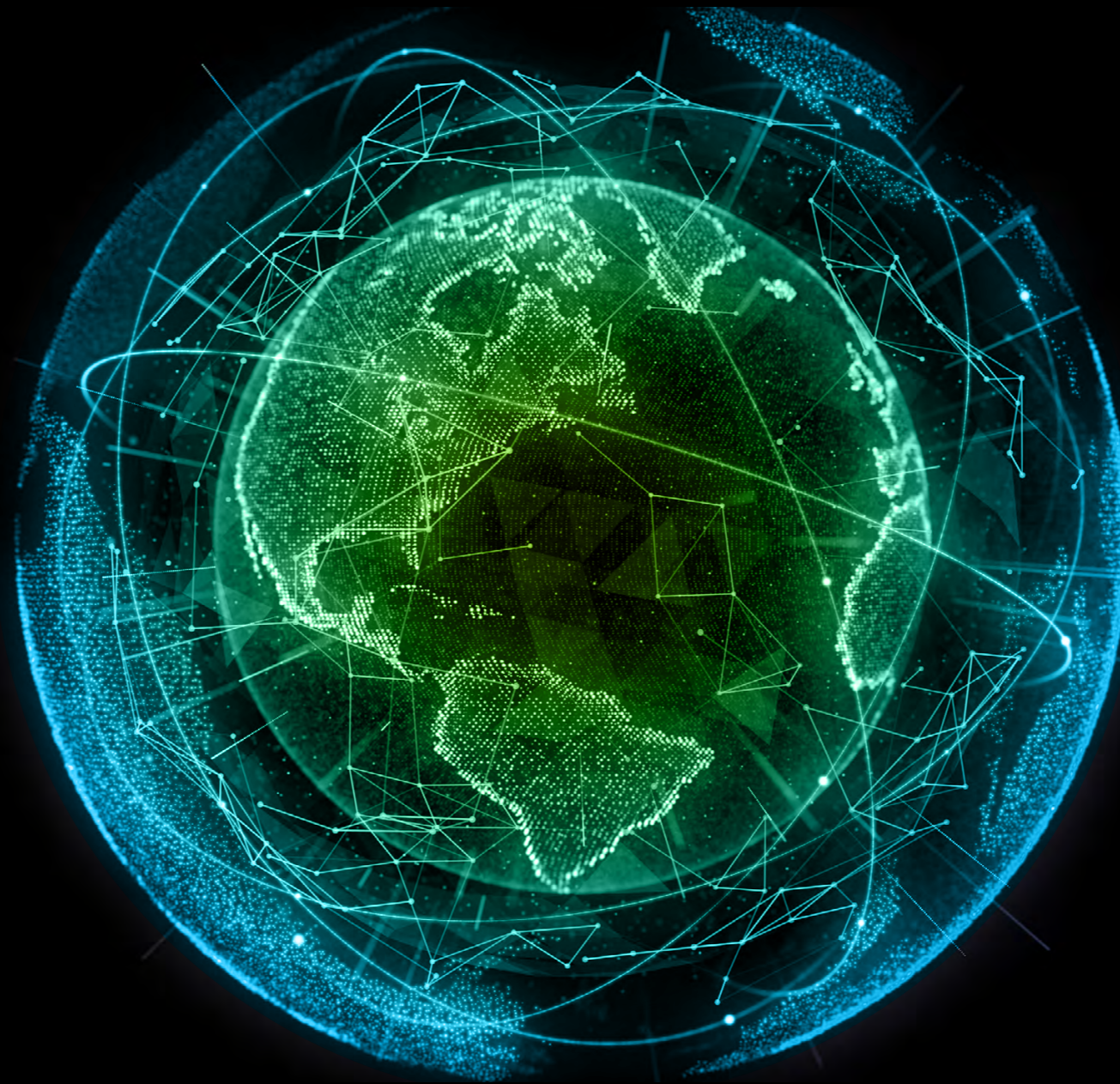

**Will 5G remake the world, or
just make it a little faster?**

That may depend on
telecommunications companies.

Deloitte Center *for*
**Technology, Media &
Telecommunications**

Contents

Introduction	04	Blockchain to blockchains	30
Communications infrastructure upgrade: The need for deep fiber	14	How 5G could enable remote healthcare through the use of AR/VR and robotic surgery	32
Spectrum portfolios in a 5G world: Rethinking the value of spectrum	18	Predictions	34
A network of networks: How will carriers handle the evolution to 5G?	20	But will consumers pay for faster connections?	37
To be or not to be: The future of the telco business model	23	Conclusion	40
Blockchain @ Telco	27		



Will 5G remake the world
or just make it a little faster?

Will 5G remake the world or just make it a little faster?

Introduction

The availability of ubiquitous high-speed mobile Internet connectivity has substantively changed the world in a short amount of time. Beginning with third-generation (3G) wireless technology, then 4G and Long-Term Evolution (LTE), consumers and business users could connect to the Internet virtually anywhere. Ever-increasing coverage, data speeds, and advancements in mobile devices helped spur the smartphone era. Today, nearly 2.5 billion people use smartphones, and 1.2 billion use tablets.¹ Over 175 billion apps were downloaded in 2017 alone. These apps, some of which have over 1 billion users,² have helped transform how we communicate, make and maintain relationships,

¹ eMarketer, 2/17, <http://mobilemarketingmagazine.com/24bn-smartphone-users-in-2017-says-emarketer>.

² App Annie 2017 Retrospective Report, <https://www.appannie.com/en/insights/market-data/app-annie-2017-retrospective/>.



Will 5G remake the world or just make it a little faster?

watch TV and movies, shop, and get from point A to point B. And while the Internet of Things (IoT) is still a developing story, devices ranging from in-home assistants to vehicles are connecting to the Internet through mobile networks. IoT will likely rely heavily upon the next generation of wireless technologies, 5G, which is poised to potentially become the most revolutionary advancement in mobile communications yet. In 2017, there were 8.4 billion connected

Will the evolution of wireless create another revolution in customer behavior and industry disruption, or simply continue what 4G started?

devices, and the figure is forecast to reach over 20.4 billion by 2020.³

In short, the combination of wireless connectivity and smartphones has sparked a global revolution that can affect nearly every aspect of a consumer's life. Companies face a world in which competitors can quickly scale their offerings to millions of consumers instantly and simultaneously, at relatively little or no cost. These include communications services (such as instant messaging), mobile financial services (such as foreign fund transfers and in-store payments), over-the-top media services (such as subscriptions to premium movies and content), location-based

³ Gartner, <https://www.cnet.com/news/at-ces-security-risks-still-a-core-internet-of-things-fear/>.

Will 5G remake the world or just make it a little faster?

services, and an almost endless list of other possibilities.

In fact, 4G (and Wi-Fi⁴) was responsible for so much change that one might wonder whether it's even possible to create another wireless technology revolution in customer behavior and industry disruption, or if changes will simply build incrementally upon what 4G started. In other words, will the future of connectivity make tomorrow mostly like today, only a bit faster? Or will it usher in a new era of capabilities, enable new business models, and

remake the competitive landscape yet again?

Recent Deloitte Global member firm research from around the world is answering these questions by taking a close look at 5G. While the technical standards are still developing, 5G has the potential to drive numerous advancements, including digital transformation across industries, providing the platform for end-to-end connectivity in IoT, enabling faster connections for consumers, and even providing a more cost-effective platform for

carriers to operate mobile voice and data connectivity. In fact, commercial applications enabled by 5G could change how multiple industries operate, while also providing much-needed revenue streams for telecommunications organizations that are struggling to recoup their investments in 4G networks,⁵ and whose relationships with consumers may be at risk of being supplanted by technology platforms.

What's so great about 5G, and why is the future of connectivity so closely tied to it? Three things, really:

A single autonomous vehicle will generate an estimated 4,000 gigabytes each day—about as much as 3,000 people.

⁴ See: Sean Kinney, "Analyst: Wi-Fi Carries 80% of Mobile Data Traffic," RCR Wireless, July 7, 2016, www.rcrwireless.com.

⁵ <https://www.morganstanley.com/ideas/5G-wireless-outlook>.

Will 5G remake the world or just make it a little faster?

speeds, low latency, and more “lanes” in the network to organize and allocate bandwidth.

Why do we need faster mobile data speeds? One big reason is video. By 2021, 78 percent of mobile data traffic will be video, up from 60 percent in 2016.⁶ A 5G network can allow a subscriber to download an HD movie in 5 to 10 seconds, compared with 10 minutes for 4G. In fact, 5G technology could deliver speeds of up to 10 gigabits per second. Such speeds can also make even more data-intensive entertainment like virtual reality viable on mobile networks, instead of relying on a Wi-Fi connection. High data speeds can be used for

more than entertainment, however, including handling data pertaining to vehicle speeds. A single autonomous vehicle could generate an estimated 4,000 gigabytes each day—about as much as 3,000 people. 5G network speeds will likely be critical for moving that much data around.

What is latency, and why is 5G’s low latency such a big advantage? Latency is the amount of time it takes a data packet to get from one point to another on a data network. Much of the excitement around 5G networks has to do with their low latency—about one millisecond. Low latency can be critical for enabling IoT. The promise

of IoT has long been touted, but the difficulty of setting up low-latency wireless networks capable of linking sensors and connected devices has typically been a serious barrier to widespread adoption. 5G can help

5G can help telecommunications companies develop critical new revenue streams while helping drive the digitization of nearly every industry.

⁶ Cisco Visual Network Index, 2017, <https://www.cisco.com/c/en/us/solutions/collateral/service-provider/visual-networking-index-vni/mobile-white-paper-c11-520862.html>.

Will 5G remake the world or just make it a little faster?

telecommunications companies develop critical new revenue streams, while helping drive the digitization of nearly every industry.

Many of the most promising IoT use cases, such as industrial automation, asset tracking, “smart city” applications, autonomous vehicles, and remote surgery, require ultra-low latency. For example, robotic surgery requires precision and “feel.” Recent advances in haptic feedback provide the surgeon an instantaneous sense of touch when using medical implements that may be located thousands of miles away.

“Network slicing” enables a single, common network infrastructure to contain multiple virtual networks.

Both precision and haptic feedback require very low latency, which 5G mobile networks can deliver.

How will 5G enable “multi-access edge computing,” and why does this matter?

Smartphones and connected devices of all kinds are consuming and generating large quantities of data at the “edge” of wireless networks. The more data that is sent to and from these mobile devices, the more strain is put on centralized cloud-based architectures, where data is processed and stored in a central location. Multi-access

edge computing (MEC) can solve this problem by providing data processing power at the edge of the mobile network. 5G networks can make MEC better by combining high speeds and low latency. The edge computing concept has long been used in Content Delivery Networks (CDNs) to handle the increased use of streaming media and over-the-top (OTT) services. With the capabilities of 5G and IoT, however, the number of use cases will likely grow far beyond just consumer and social content—increasing the need for advanced MEC.



Will 5G remake the world or just make it a little faster?

Wireless service providers (WSPs) can integrate small data centers into their 5G network nodes instead of sending data all the way back to a centrally located data center. At the edge, companies can use data analytics and artificial intelligence to generate more value from data, and to help enable data-intensive applications. Again, consider roads full of autonomous vehicles, each generating huge amounts of data that require real-time processing. Cloud-based networking and data processing are simply unworkable; large-scale adoption will likely require data processing at the edge, in addition to low-latency

wireless networks. Edge networks can also sort through data, sending valuable information to centralized data centers and discarding the rest. Industry 4.0 applications and augmented reality/virtual reality (AR/VR) on mobile devices are other use cases that can benefit from 5G-enabled MEC.

Will 5G enable more lanes per network? 5G networks can accommodate several dedicated “lanes” on the same network infrastructure. This is called “network slicing.” Instead of having to build several dedicated networks for different technical requirements,

a WSP can use a common network infrastructure to create multiple virtual networks. It can then deliver “network-as-a-service” to customers with varied use cases. For example, an IoT application might require very low latency, but also low data throughput. A VR application, on the other hand, could have less-critical latency requirements, but high data throughput.

With so much potential, what can stop 5G from having a huge impact, and soon? And what are some of the most promising sources of revenue for WSPs? Deloitte member firms from across the globe are

5G makes it critical for wireless service providers to value accurately their most important resource: wireless spectrum.

Will 5G remake the world or just make it a little faster?

tackling these questions.

First, 5G will require significant investment in network infrastructure, especially in the deployment of deep fiber (i.e., fiber optic cable closer to end users). Deep fiber is critical for 5G networks, which operate at higher frequencies than 3G and 4G networks.⁷ These frequencies do not travel as far, and are more susceptible to interference, requiring a substantial increase in the number of cell sites. Although these sites utilize small cells as opposed to large/macro cells, these small cells can still require high-speed backhaul to the cell site. In the United States, however, not

enough deep fiber is in place to support the number of anticipated cell sites needed for 5G and beyond. Significant investment will likely be required if WSPs are to take advantage of the revenue streams 5G can provide. The need for investment comes at a challenging time for many telecommunications organizations: maintaining their legacy networks can be costly, and wireless substitution and competition from cable companies for home broadband have reduced their customer base. Finally, they will likely need regulatory reform from the US government to improve competition and hard

dollars to spread the cost of deep fiber deployment, particularly in rural and underserved areas.

[Communications Infrastructure Upgrade: The Need for Deep Fiber](#) from Deloitte explores why

While 5G offers many revenue opportunities for wireless service providers, it also contains inherent threats to their current business model.

⁷ "Deep deployment of fiber optics is a national imperative," <https://www2.deloitte.com/us/en/pages/consulting/articles/communications-infrastructure-upgrade-deep-fiber-imperative.html>.



Will 5G remake the world or just make it a little faster?

more deep fiber is needed for 5G to flourish, and how the US government and telecommunications organizations can work together to fund and deploy it.

Beyond the fiber/core network, the advent of 5G can also make it critical for WSPs to value accurately one of their most important resources: wireless spectrum. Spectrum that was formerly considered “subprime,” including high-frequency and fragmented spectrum, are now commonly more valuable given technology advancements that enable WSPs to leverage these spectrum allocations. 5G technology

that utilizes high spectrum bands, carrier aggregation methods, and spectrum sharing models, combined with new regulations, can open the potential for a wide range of increasingly complex and demanding use cases. Deloitte’s [Spectrum Portfolios in a 5G World](#) can help WSPs see their spectrum as a portfolio, add to it strategically, and assess its value. Investors also can benefit by understanding what a WSP’s portfolio is worth, and how it can hasten—or hinder—revenue growth.

While 5G offers many revenue opportunities for WSPs, it also can

contain inherent threats to their current business model. 5G can allow devices to connect to multiple types of networks, potentially from different service providers. Thus, it can separate a critical linkage for telecommunications organizations: the network and the consumer’s end device. [A Network of Networks](#) explores how 5G creates challenging “separations,” and what telecommunications organizations can do to reconnect them. The paper also explores the disruptive potential that WSPs can bring to landline-only residential broadband providers, given that the dramatic speed increase expected with 5G could

Blockchain has the potential to simplify the provisioning of services and determining of usage rates through automated contracts.

Will 5G remake the world or just make it a little faster?

overtake landline performance for many applications.

The piece focuses on the possible separation of network and device led by Deloitte Germany, and examines a scenario in which carriers acknowledge that OTT players have won the battle for the consumer. That can then lead them to focus on providing network services. [Telco 2030](#) ponders this and other existential questions about what the future will hold.

The separation of network and device can also pose technical challenges. One of the biggest benefits of 5G is ubiquitous access

across various networks by a wide range of devices, including smartphones, IoT endpoints, and connected vehicles. To offer seamless connectivity—and get paid for it—telecommunications companies should consider determining the fastest connection for each device that accesses its network, and then charge accordingly for that access.

Blockchain technology has the potential to solve these technical challenges by simplifying the provision of service and determining usage rates through automated smart contracts, as Deloitte South Africa shows in its

[Blockchain@Telco](#) report. Although smart contracts can be useful for 5G and beyond, Deloitte highlights some of their risks in [Blockchain to Blockchains](#).

The ability to provide network-driven services to enterprises, the public sector, and healthcare institutions can offer possible revenue streams for telcos. In [How 5G Could Enable Remote Healthcare Through the Use of AR/VR and Robotic Surgery](#), Deloitte Australia explains how 5G's faster speeds, lower latency, and increased reliability can benefit patients in rural and underserved areas.



Will 5G remake the world or just make it a little faster?

And, it's too early to count out the ability of telcos to compete for a bigger share of consumer spending. In fact, 5G could allow telcos to compete with cable companies for home broadband—and the entertainment bundle that home broadband anchors. [Global Predictions](#) shows how a “mobile

only” future could become a reality for a wider range of people. But for 5G to win consumers over, it will likely have to make economic sense. 4G is already faster than many consumers' Wi-Fi connections, as we discovered from our [Global Mobile Consumer Survey](#).

excerpt 01

Communications infrastructure upgrade

The need for deep fiber

Unlocking the full potential of 5G in the United States rests on a key assumption: the extension of fiber deep into the network. Despite the demand and potential economic benefits of fiber deployment, the United States lacks the fiber density in access networks to make the bandwidth advancements necessary to improve the pace of innovation and economic growth. Increased speed and capacity from 5G will rely on higher frequencies and network densification. Carriers will deploy many more small cells, homespots, and hotspots in higher bands, with a coverage radius measured in meters versus kilometers.

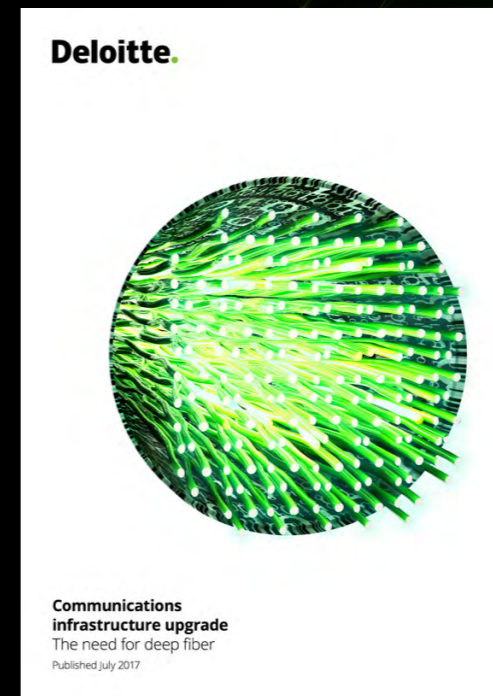

[Download the publication](#)

A Deloitte Consulting LLP analysis estimates that the United States requires between \$130 billion and \$150 billion over the next five to seven years to adequately support broadband competition, rural coverage, and wireless densification. Fiber density is critical to support the next round of innovation and Internet access for America. Deep fiber can facilitate high-speed access to more homes, more businesses, and support hundreds of thousands of new cell sites and hotspots for 5G.

Previous generations of wireless technology (i.e., 3G and 4G) relied on broader blocks of spectrum and improved spectral efficiency to generate higher speeds and

increased capacity. Increased speed and capacity from 5G will rely more heavily on the use of higher frequencies and densification. Deploying fiber closer to customers can enable efficient transport of increased wireless traffic from that densification.

Carriers are already purchasing and testing high-frequency spectrum (both licensed and unlicensed) to solve capacity constraints. Rather than building macro towers with mid- or low-band spectrum, carriers will deploy lower-powered small cells and rely on homespots and hotspots, each with a coverage radius measured in meters versus kilometers. Densification of access

points with small coverage areas implies that fewer users share the network capacity produced by 5G small cells, generating enormous performance gains.

Transmission at higher frequencies exhibits more limited propagation characteristics than transmission at lower frequencies. The signals cannot reach as far and have more difficulty penetrating walls or other barriers. Therefore, network densification becomes an even greater imperative. Such densification is challenging, given current fiber deployment limitations and the upgrade costs and deployment cycle times associated with traditional network architecture.

Excerpt: Communications infrastructure upgrade: The need for deep fiber

Small cells need connections to fiber/cable backhaul to realize capacity and speed potential.

Homespots and hotspots require high-speed broadband connections to homes and businesses. Without deeper fiber deployment, carriers will be unable to support the projected fourfold increase in mobile data traffic between 2016 and 2021. Exhibit 1 below shows how fiber is a critical component to realizing opportunities for the economy as it expands into communities to promote competition, increases connectivity for rural customers and the underserved, and supports densification for wireless.

Wireless substitution and cable competition have taken a toll on most wireline carriers' customer bases, leading to challenging economics and limited funds for fiber deployment.

[Return to table of contents](#)



Excerpt: Communications infrastructure upgrade: The need for deep fiber

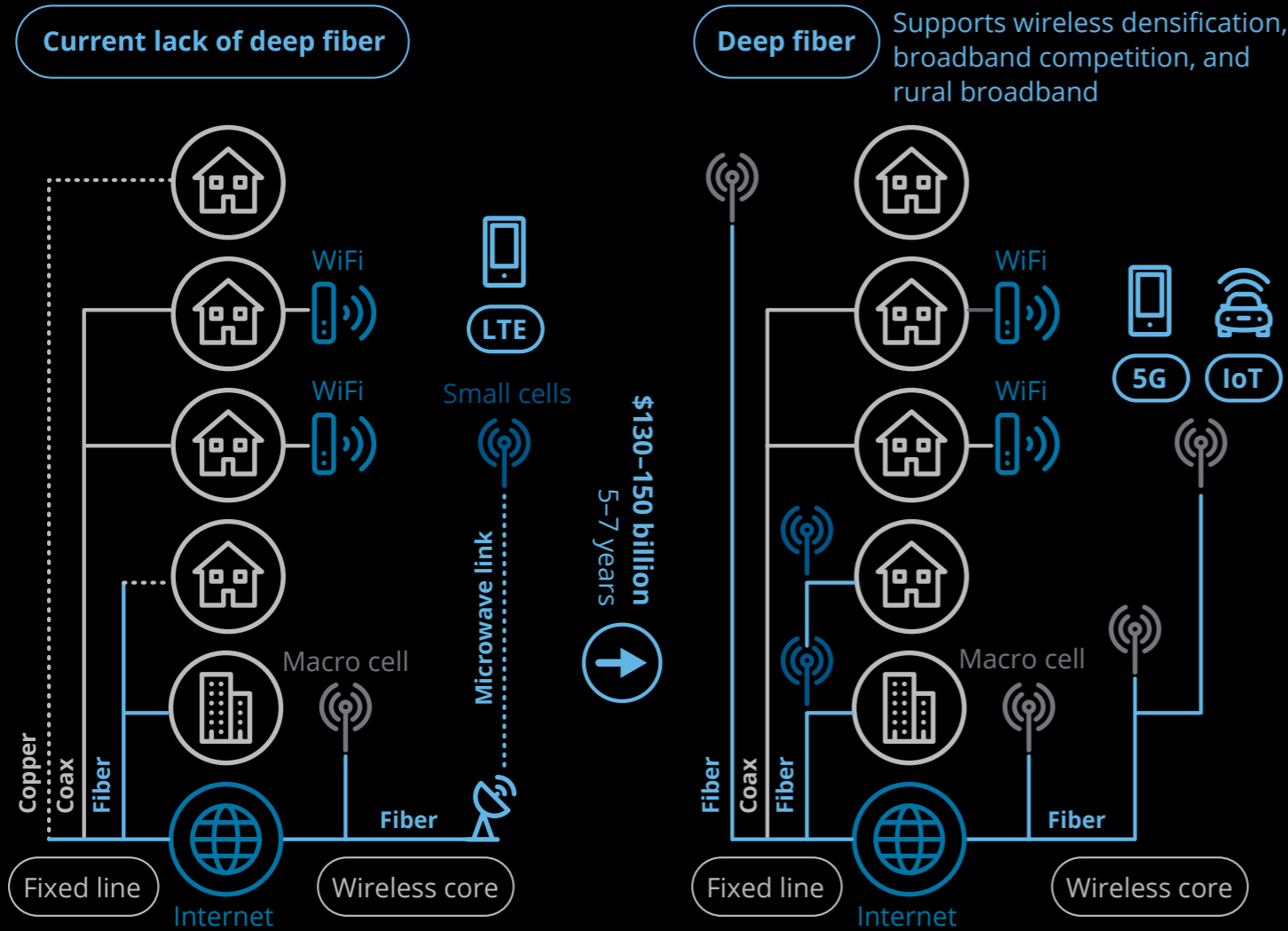

Contact

Dan Littmann
Principal, Deloitte Consulting LLP
dlittman@deloitte.com

Craig Wigginton
Partner, Deloitte & Touche LLP
cwigginton@deloitte.com

Phil Wilson
Managing Director, Deloitte Consulting LLP
phwilson@deloitte.com

Brett Haan
Principal, Deloitte Consulting LLP
bhaan@deloitte.com

Jack Fritz
Sr. Manager, Deloitte Consulting LLP
jacfritz@deloitte.com

excerpt 02

Spectrum portfolios in a 5G world

Rethinking the value of spectrum

The advent of 5G will have a profound impact on the value of WSPs' spectrum portfolios. Network architectures and use cases will dramatically shift, leading to changes in the underlying drivers of value for every frequency band, and creating even greater complexity in the effort to value portfolios properly. The market values of spectrum holdings will continue to diverge from their historical prices and become more greatly influenced by how each band complements the broader spectrum portfolio in the overall effort to meet business objectives.

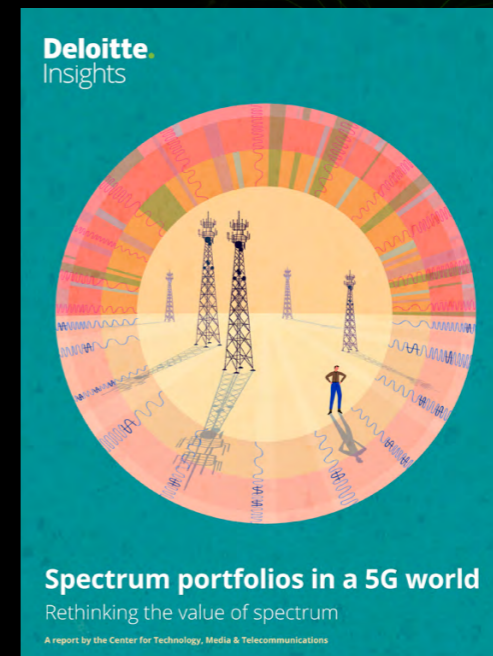

[Download the publication](#)

The long-standing relationship of a device communicating with a single tower, tracking its connection with other towers, and handing off to the next-best tower as the user moves will change. The architecture of 5G allows devices to communicate simultaneously with several towers, over several frequencies, and even using several radio protocols, profoundly transforming the current paradigm and allowing multilevel network deployment. Femto cells and homespots (both user-hosted devices) connected to broadband will combine seamlessly with wide-area network assets. New architectures dependent on lower-cost cell sites will achieve greater performance and reliability

through sheer numbers. Even direct device-to-device communications will become practical.

In this environment, WSPs will continue to prefer owning larger blocks of contiguous spectrum, and contiguous blocks will likely remain more valuable than smaller, more fragmented blocks. But the emergence of new technologies such as carrier aggregation and multi connectivity will allow network operators to logically combine fragmented spectrum and physical assets to offer the same capacity to end users.

[Return to table of contents](#)

Contact

Craig Wigginton

Partner, Deloitte & Touche LLP
cwigginton@deloitte.com

Dan Littmann

Principal, Deloitte Consulting LLP
dlittman@deloitte.com

Jim Nason

Partner, Deloitte Tax LLP
jnason@deloitte.com

Orlando Setola

Principal, Deloitte & Touche LLP
osetola@deloitte.com

excerpt 03

A network of networks

How will carriers handle the evolution to 5G?

5G will create new opportunities for established telecom players as they try to generate new revenue streams and retain their customer relationships. It will likely also usher in opportunities for disruptive entrants into the ecosystem—a potential threat to current players, driven largely by network value driver separation.

Separation of value drivers from the network.

The evolution of mobile generations has seen a shift in the relationship between the user and the network operator.

We can characterize this through three main events:



[Download the publication](#)

1. Separation of service.

Applications and services are becoming agnostic as to the mobile network on which they're riding—for instance, consumers will likely

increasingly use Internet Protocol (IP)-based instant messaging in lieu of the more hardware-based short message service. Often termed over-the-top services, these come out of

previous/existing wireless service generations but can be expected to continue/evolve into 5G.

2. Separation of device.

Once inextricably linked in the US market, devices are increasingly becoming agnostic as to particular carrier networks, with regulation and competition aiding a rapid shift away from this model. Consider the shift from subsidized mobile phones with service plans to those with equipment installment plans. Indeed, demand for buying devices under installment plans is increasing rapidly, with every leading telecom carrier generating higher equipment revenues from installment plans and leasing programs. This shift has the

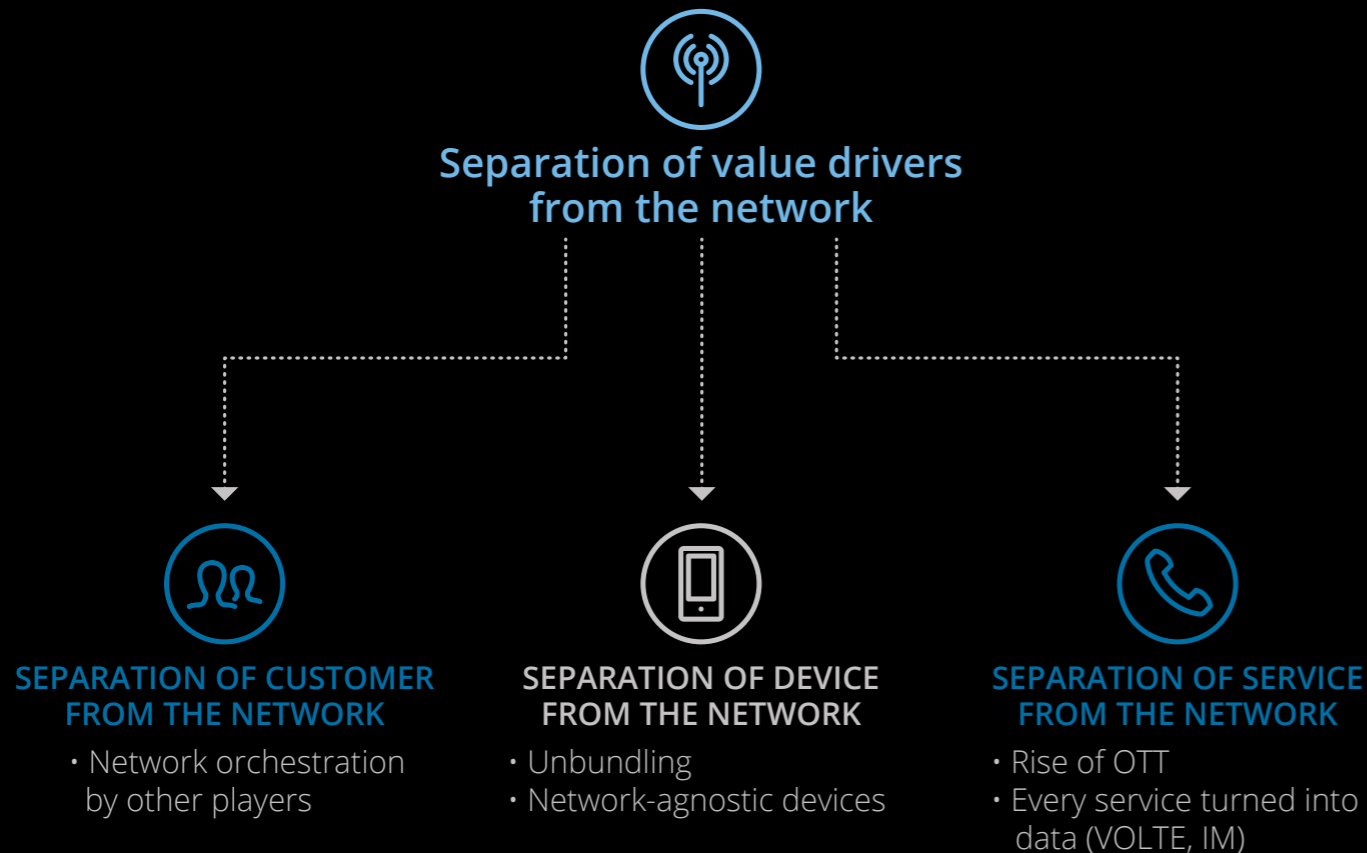

Excerpt: A network of networks: How will carriers handle the evolution to 5G?

potential, however, to create less “stickiness” to any specific network provider and may impact the time that a consumer uses a particular device, potentially slowing down the rate of smartphone refresh.

3. Separation of customer.

Customers are increasingly becoming disconnected from any specific type of network. While once they had to choose between carrier cellular and private/public Wi-Fi, customers now have multiple options that combine elements of both. These alternatives may even

make the network and equipment providing the signal virtually invisible to the person looking at her smartphone. We believe this is one of the big changes that 5G core specifically brings to the table.

[Return to table of contents](#)

Contact

Phil Wilson

Managing Director, Deloitte Consulting LLP
phwilson@deloitte.com

Craig Wigginton

Partner, Deloitte & Touche LLP
cwigginton@deloitte.com

Mike Curran

Senior Manager, Deloitte Consulting LLP
mcurran@deloitte.com

excerpt 04

To be or not to be

The future of the telco business model

What does “separation of device” mean for the future of telcos?

As we look to the future and take into account critical uncertainties, four possible scenarios rise to the top. In “The engineer strikes back,” telco operators master both customer relationships and the technology layer. In the second scenario, “The new wholesale truth,” telcos have been driven out of the customer domain but remain masters of the technology. Telcos retain the primary customer relationship but transfer the technology entirely to vendors in “The virtual telco” scenario. In the last scenario, “A vendor brand,” telco players are driven out of both domains. Let’s take a closer look at scenario 2: The new wholesale truth.

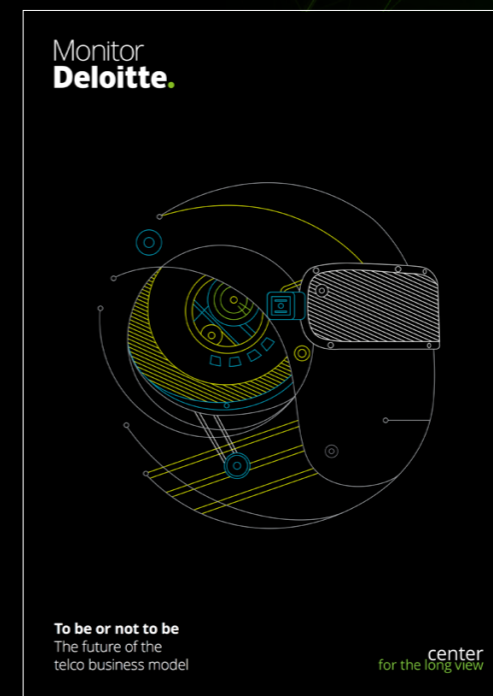

[Download the publication](#)

Scenario 2: The New Wholesale

Truth. In this scenario telco companies have finally lost the end-user control points they cherished for so long. To remain relevant, telcos have gone back to taking full control over the network technology where they still have their core competencies.

Network/Technology. Telcos are focusing on fixed and mobile network infrastructure, so they have installed cutting-edge fixed broadband, 5G networks, or both technologies that are central to the orchestration of network mesh-ups. Telcos are the only source of innovation for new mobile and fixed broadband-based services; however,

this expansion is very capital-intensive and therefore limited by the telcos' ability to refinance their investment. Global telco alliances push new standards, shape the industry landscape, and facilitate partnerships.

Telcos own and orchestrate the technological part of the value chain and form the intermediary between vendors and OTTs, who own the end-user relationships.

Customer Relations. End-user devices are separated from the network and enable easy switching of network operators with soft SIM technologies. OTTs and device producers have taken advantage

of alliances to disrupt the market, which has enabled them to take over the customer relationship.

Generally, connectivity is a low-value commodity whereby the end-user segment offers very low margins to all players engaged in basic connectivity. Every citizen has the right to a 100-MBit connection at home, which is financed with public network levies. Although many customers pay for connected services and superior bandwidth, these cash flows go only indirectly to telcos, as most revenues are generated by large tech companies, device manufacturers, and OTTs. By now, customers can choose to obtain connectivity and a service

Excerpt: To be or not to be: The future of the telco business mode

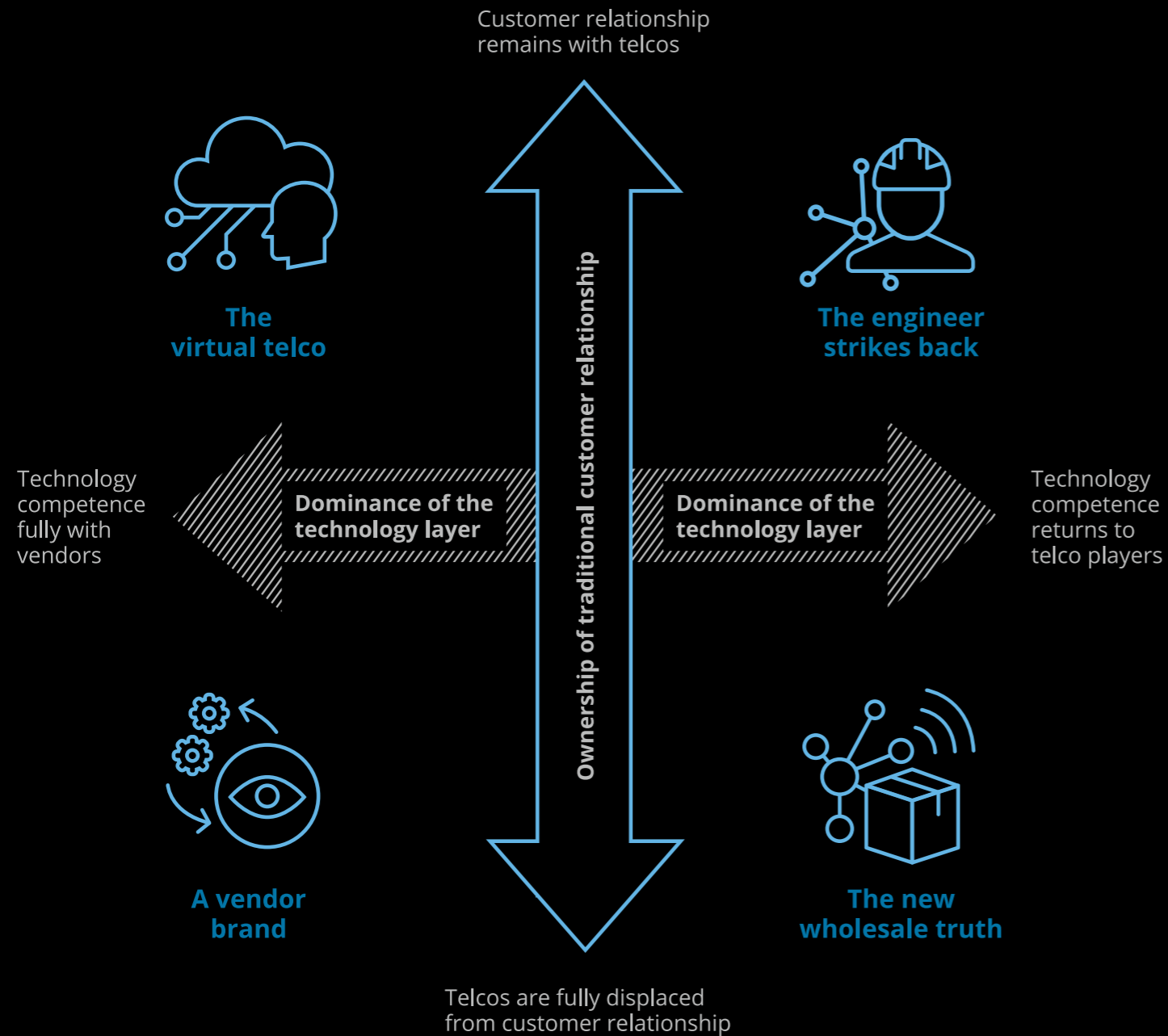

level either with a device or through a provided service.

As a key economic factor, the government takes an active part by publicly subsidizing the infrastructure and the necessary innovation to connect the entire population with high-speed Internet and telco services. This makes telcos the lubricant behind the scenes that keeps the system running, as society and the economy depend on the services they offer.

Business Model. In this scenario, the telco business model needs to be refined to enable them to succeed as a “smart pipe” provider, since they can offer wholesale

products only to OTTs. This development can already be seen, as today's customers spend more time with OTT-developed products such as WhatsApp or Snapchat than with traditional telco services. Microsoft's communication tool Skype already carries more than 25 percent of all global cross-border call traffic.

Telcos have taken over the role of greenkeeper for the publicly funded network. Their main customers are OTTs who lease network capacity to provide services to their end users. In the buyer's market of network infrastructure, the telcos have a good bargaining position; as hardware vendors rely on them, and

since they run the publicly funded network, the telcos benefit from their scale and manage external networks for third parties such as municipal utility providers, charging them for this service.

[Return to table of contents](#)

Contact

Alexander Mogg
Partner, Monitor Deloitte
amogg@deloitte.de

Tim Bottke
Partner, Monitor Deloitte
tbottke@deloitte.com

Dr. Andreas Gentner
Partner, Deloitte Consulting
agentner@deloitte.com

Dr. Florian Klein
Director, Monitor Deloitte
fklein@deloitte.com

excerpt 05

Blockchain @ Telco

5G technology implementation is another example to potentially benefit from the blockchain to streamline processes. To realize the 5G promise of ubiquitous access across various networks, CSPs will need to handle heterogeneous access nodes and diverse access mechanisms. Selecting the fastest access node for every user or machine will be a central challenge in the future. Blockchain can enable a new generation of access technology selection mechanisms to build sustainable solutions.

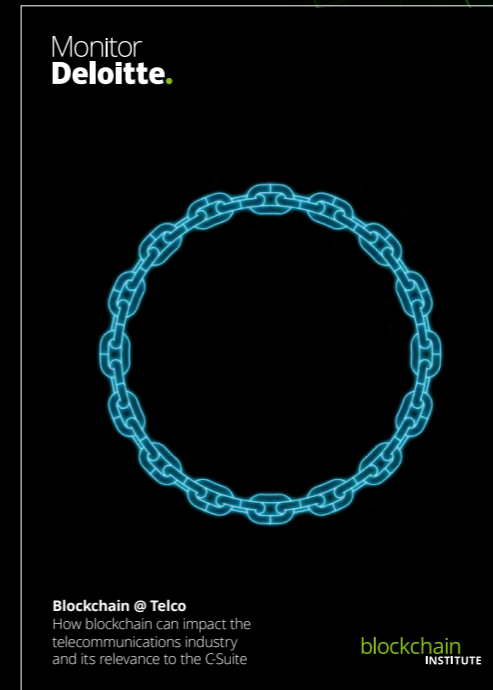

Download the publication

Current system. Access Network Discovery and Selection Function (ANDSF) is an entity within the EPC (Evolved Packet Core) that helps in the discovery/selection of access networks, such as Wi-Fi, WiMAX, and LTE in the device vicinity, providing them with rules policing the connection to these networks. It consists of a list of access networks, such as Wi-Fi, that may be available in the vicinity of a device. This information is received in response to a device request that contains its location and capability, such as types of supported interfaces, among others. The received information assists the device in expediting connection to these networks.

The ANDSF response contains the following information: the type of access technology (Wi-Fi, WiMAX, etc.), the access network identifier, and the technology-specific information (such as one or more carrier frequencies).

Current challenges. The system is centralized in a client-server model where the rules stored on the server (ANDSF) are pushed to the client (device). This causes delays and does not allow for seamless provisioning among access networks for the device. Also, the provisioning of rules is not a real-time process, meaning the rules cannot be changed dynamically.

Blockchain-based solution:

The 3GPP (LTE, GPRS) and non-3GPP (WiMAX, WLAN, Wi-Fi) access networks in a given area can be networked via a blockchain where each access point (Wi-Fi router, SP cell tower, etc.) can serve as a node in the network monitoring the devices. Rules and agreements among the various access-providing networks can be coded as “smart contracts.” These contracts can be dynamic in nature; any time a policy needs to be changed, only the contract code needs to be changed. When a device broadcasts its identity, it is accepted into the network by the corresponding CSP cell. Once the device broadcasts its location, the access node that

can best provide service to the device is called upon to do so. This also allows for seamless rating and charging of all services among the various access nodes. If, for example, a WLAN from an office or a home network has provided access to a device, then the CSP can conceivably reduce the bill amount appropriately for the invoice of the accommodating company or home. Location-based services can also be enabled by being a part of this blockchain network and hence always know which devices are in the vicinity.

[Return to table of contents](#)

Contact

Milan Sallaba

Technology Sector Head, Germany
msallaba@deloitte.de

Mirko René Gramatke

Director, Monitor Deloitte
mgramatke@deloitte.de

excerpt 06

Blockchain to blockchains

Smart contracts can encode complex business, financial, and legal arrangements on the blockchain, so there is risk associated with the one-to-one mapping of these arrangements from the physical to the digital framework. Additionally, cyber risks increase as smart contracts rely on “oracles” (data from outside entities) to trigger contract execution. Smart contracts apply consistently to all participant nodes across the network; they should be capable of exception handling that adheres to business and legal arrangements, and complies with regulations. Like other software code, smart contracts require robust testing and adequate controls to mitigate potential risks to blockchain-based business processes. For example, smart contracts allow for straight-through processing (contractual clauses may be made partially/fully self-executing or self-enforcing, or both) as they directly interact with other smart contracts. One corrupted smart contract could cause a chain reaction that paralyzes the network.



[Download the publication](#)

Successful adoption of any new technology is dependent on appropriate management of the associated risks. This is especially true when that technology is part of the organization's core infrastructure, as is the case with blockchain. Additionally, it's important to understand the evolution of regulatory guidance and its implications. For example, the Financial Industry Regulatory Authority has shared operational and regulatory considerations for developing use cases within capital markets. Organizations should work to address these regulatory requirements in their blockchain-based business models and establish a robust

risk-management strategy, governance, and controls framework.

[Return to table of contents](#)

Contact

David Mapgaonkar

Principal, Deloitte and Touche LLP
dmapgaonkar@deloitte.com

Prakash Santhana

Managing Director, Deloitte Analytics LLP
psanthana@deloitte.com

Darshini Dalal

Manager, Deloitte Consulting LLP
ddalal@deloitte.com

excerpt 07

How 5G could enable remote healthcare through the use of AR/VR and robotic surgery

VR and AR applications are currently used in healthcare, but there are other health applications that would benefit from greater reliability in network connections. One application is telehealth. Australia has a geographically disparate population. In some cases, it can be difficult for people living in remote areas to gain access to health services. Mobile networks have enabled telehealth to help address this issue. For example, Telstra's Anywhere Healthcare provides virtual clinics, so that people living in regional areas can talk to a specialist using specialized equipment at their local GP.⁸ This significantly reduces week- or month-long waiting times to see specialists.



[Download the publication](#)

⁸ Telstra, 2017

Telehealth in regional areas can often suffer from a lack of reliability in connections; audio and picture can lag significantly, and in some cases, users experience connection dropouts. Hence, a more reliable connection is needed.

Improvements in connection reliability will act further to enable VR and AR experiences. While these technologies and use cases are becoming more prevalent, improvements in their operation are likely to have significant benefits for industries such as healthcare, education, and training. For example, firefighters can be trained to fight fires without being in real danger.⁹ VR is valued for its ability to simulate real-life situations. In Australia, the

National Institute for Experimental Arts at the University of New South Wales has used VR to allow cancer researchers to see a scan of a breast cancer cell in a virtual world, where they can see how drugs enter cells to help design appropriate chemotherapy drugs.

Another significant technological advancement in healthcare has been telesurgery. The da Vinci Robot allows surgeons to do their work remotely, at a distance from the actual patient.¹⁰ As the surgeon sits at a special console, 3D cameras inserted into the patient provide a magnified 360-degree view of the area requiring surgery. Using controls, the surgeon manipulates

robotic arms with surgical instruments to perform the operation. In the future, greater connection reliability will enable telesurgery at greater distances.

[*Return to table of contents*](#)

Contact

John O'Mahony

Partner, Deloitte Touche Tohmatsu
joomahony@deloitte.com.au

Jess Mizrahi

Manager, Deloitte Services Pty Ltd
jmizrahi@deloitte.com.au

⁹ 360immersive, 2016

¹⁰ UnityPoint Health, 2017

excerpt 08

Predictions

Could home broadband be a potential revenue stream?

Wireless networks are expected to improve dramatically as 5G wireless networks are deployed, with gigabit speeds expected. These networks are expected to launch in the United States by 2020, but exact launch dates will vary by country. 5G is made possible by many different technologies, but a critical one is the use of new radio wavelengths.

Millimeter wave (mmWave) fixed wireless access (FWA).

Historically, although frequencies that were much higher than traditional cellular frequencies theoretically had lots of room to carry data, they were not of much use practically. Technology to transmit and receive these frequencies was expensive and hard to develop, and the radio waves themselves propagated poorly. Although cellular frequency radio waves can travel for kilometers, go around buildings, and penetrate windows, people believed that the much shorter radio waves at over



Download the publication

24 GHz—also known as millimeter wave, or mmWave—could travel only 200 yards before being absorbed by the air, could not penetrate glass or even the leaves of a tree, and worked only in the line of sight. But Deloitte Global predicts that in 2018 there will be significant further trials in the United States of technologies using frequency bands around 28 GHz, 37–40 GHz, and 64–71 GHz (11 GHz of spectrum) as laid out in the new rules proposed by the Federal Communications Commission.¹¹ These trials will not, at first, be focused on mobile devices (that will happen in 2019 and 2020), but will instead be for non-mobile home Internet access. The technology uses small digital

antennas mounted on the outside of homes, located about a few hundred meters from small microcell transmitters (usually on utility poles rather than on traditional, much larger and more expensive cell towers, but often connected to high-speed fiber optic cables as part of ongoing network densification efforts) and with a direct line of sight between the home and the transmitter.

Speeds are potentially much higher than 4G, with 1 to 2 Gbps being the likely minimum and 10 Gbps possible, all with latency of less than 10 milliseconds. This is known as fixed wireless access, and major North American carriers, as well as

potential non carrier entrants in the wireless ISP market, are doing multiple trials in 2017 and 2018.¹² From what we know only from public announcements, this technology is being tried in over 15 US markets, with the first commercial launch from one carrier scheduled for late 2018.¹³ Very importantly, the trials are revealing that mmWave technology may be working better than predicted; some trials have seen 1.4 Gbps speeds at distances of about a quarter of a mile and from behind a building.¹⁴ If this proves the case in larger trials, it would make the technology significantly more useful. It is early days, but Deloitte Global is predicting that this technology will

be useful in at least some locations and for some customers, and is likely to capture a small but growing portion of the home Internet market by 2022. Further, due to the high speeds and small cell sizes, monthly capacity will be very high, and each home is likely to be able to use over a TB (terabyte) per month. Those who already have fiber optic connections are unlikely to switch, and even those who have DOCSIS 3.1 cable connections and G.fast telco connections (both of which will probably offer 1 Gbps speeds or more by 2022) may not move to mmWave. But as we have seen in our mobile-only predictions for 2018, there are still many people who are not paying for wired access. By 2022,

wireless home Internet solutions will continue to occupy the low end of the market (homes using relatively little data), but they are also likely to be competing at the high end of the market and sometimes displacing fiber-to-the-home solutions.

[Return to table of contents](#)

Contact

Paul Lee

Partner, Deloitte Touche Tohmatsu Limited
paullee@deloitte.co.uk

Duncan Stewart

Director, Deloitte Canada
dunstewart@deloitte.ca

excerpt 09

But will consumers pay for faster connections?

There are two aspects of the wireless network that consumers fundamentally care about: performance and cost. Together, these two factors shape consumer choices among different networks—Wi-Fi or cellular—with due consideration of performance and cost. The 2017 survey findings show an increased preference for Wi-Fi compared with previous years. Exceeding the limit of a data plan likely plays a key role in user preference for Wi-Fi over cellular networks. Since 2013, Wi-Fi has generally been the preferred means of connecting to the Internet with a mobile device. That trend has increased substantially since 2016, with 53 percent preferring Wi-Fi then to 67 percent in 2017.

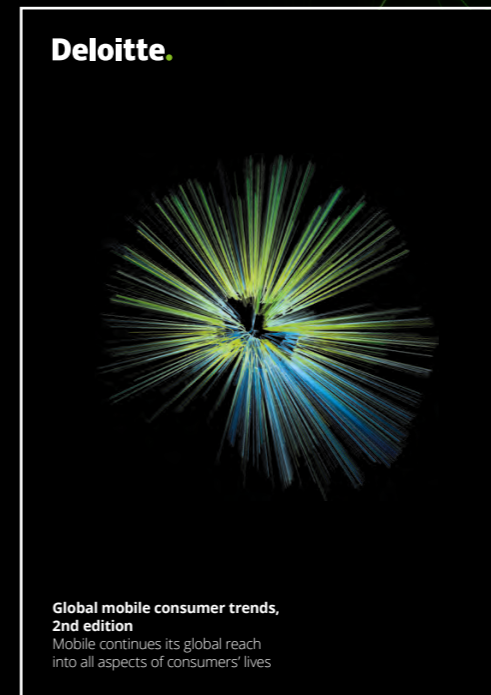

[Download the publication](#)

Excerpt: But will consumers pay for faster connections?

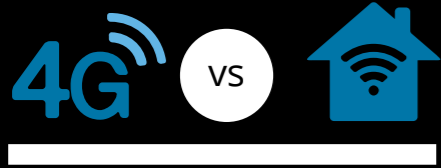

	Developed	Developing
Net: 4G is faster	27%	37%
Net: 4G is slower	20%	24%

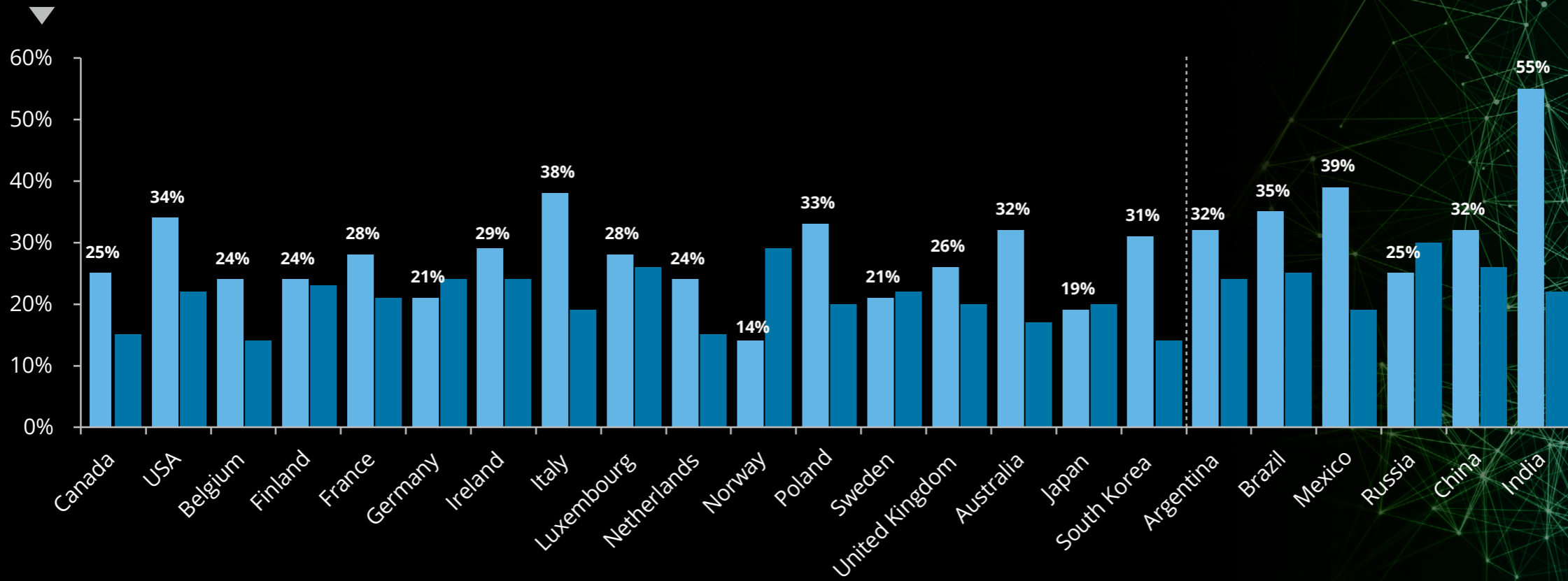

▼ Note change in scale

Q. How do the 4G speeds on your phone compare with Wi-Fi speeds in the following places?: At home (FASTER, SLOWER: NET)
Base: Avg. per country 919 (smartphone owners only)

Excerpt: But will consumers pay for faster connections?

Looking to 5G, the next generation of mobile networks, about half of consumers think that 5G is important. Sixty-four percent of those ages 25 to 34 find 5G important, the highest level of interest by any age group. With 5G network deployments expected to begin in earnest in 2018 (with substantially higher data speeds than 4G), the competition between cellular and Wi-Fi could be poised for a substantive shift next year, again toward cellular—but only if the cost makes sense.

[Return to table of contents](#)

Contact

Craig Wigginton

Partner, Deloitte & Touche LLP
cwigginton@deloitte.com

Mike Curran

Senior Manager, Deloitte Consulting LLP
mcurran@deloitte.com

Will 5G remake the world or just make it a little faster?

Conclusion

Research from Deloitte Global member firms around the world shows that 5G holds enormous promise. Split-second downloads of video content, virtual reality, autonomous vehicles, remote surgery, and industry-shaping IoT connections are just a handful of the use cases that 5G can enable. But our research also illustrates that there are some hurdles ahead. The fundamental question with which we opened—“Will 5G remake the world, or just make it faster?”—will likely be answered by players in the market. How well and quickly will they clear these hurdles? Will they receive help from governments and industry associations? And will carriers use these high-speed, low-latency connections to develop the kinds of services that will enable the next wave of innovation? Future research from Deloitte Global member firms will surely seek answers to these questions. For now, we will close by taking a quick look at the current state of 5G development and short-term forecasts.



Will 5G remake the world or just make it a little faster?

When will 5G come?

Many carriers still face challenges and uncertainties as they roll out 5G services, but many are moving ahead with both trials and major investments. Many companies that make hardware for 5G devices are unveiling commercial products. 5G-ready smartphones could hit the market as soon as 2019 and fuel the next wave of sales as early adopters trade up. By 2020, around 7 percent of smartphones could be equipped for 5G.¹¹ By 2023, there could be over 1 billion 5G subscribers, accounting for over 10 percent of all mobile broadband subscriptions and 20 percent of all mobile data.¹²

Where will we see 5G first?

China, South Korea, and the United States appear to have an early lead in bringing 5G services to market.¹³ Carriers in all three countries have completed 5G trials, and several of them plan to launch limited commercial services in 2018.¹⁴ Most services will launch in 2019–2020; however, as networks get built and 5G chipsets become more common in smartphones. 5G adoption is forecast to accelerate rapidly in several markets. By 2023, nearly half of North American mobile subscriptions could be 5G, along with 34 percent of those in northeast Asia, led by China and South Korea (see figure 1).

¹¹ According to IDC, 7 percent of all smartphones will be 5G-enabled by 2020. <https://www.digit.in/mobile-phones/smartphone-sales-in-2019-will-be-all-about-5g-6-inch-displays-and-india-report-41345.html>.

¹² Ericsson Mobility Report, June 2018, <https://www.ericsson.com/assets/local/mobility-report/documents/2018/ericsson-mobility-report-june-2018.pdf>.

¹³ CTIA, April 2018, <https://www.ctia.org/news/race-to-5g-report>.

¹⁴ For example, “When Is 5G Coming to the US?” <https://www.lifewire.com/5g-availability-us-4155914>.

Will 5G remake the world or just make it a little faster?

Mobile subscriptions by region and technology 2023 (percent)

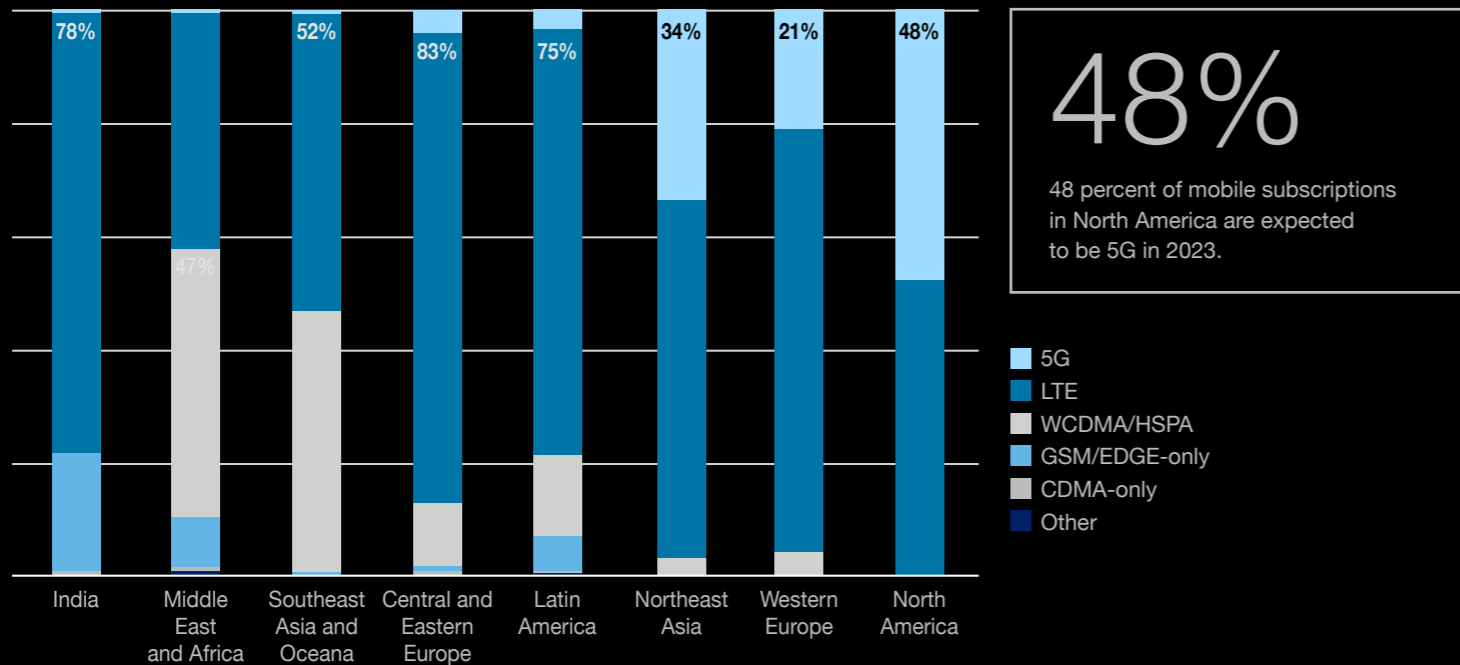

Source: Ericsson Mobility Report, June 2018

Do governments around the world see 5G as a race?

One can argue whether countries and carriers are competing in a race to see who can harness 5G first.¹⁵ Nevertheless, the belief that

technological leadership is the key to economic competitiveness means that 5G is a strategic priority for many governments, as well as companies.¹⁶ For example, by some estimates, the US economy gained

\$100 billion through 2016 thanks to its leadership in developing 4G networks.¹⁷

Economic competitiveness is only part of the story. Intensifying international rivalries, and the central role that wireless networks play in collecting and distributing data, mean that national security concerns are coming to the fore. Fears that any country—and its equipment providers—could dominate 5G are forcing governments to consider how they can accelerate 5G deployments, and to whom they should trust the

¹⁵ "Does It Matter If China Beats the US to Build a 5G Network?" *Wired*, 6/6/18, <https://www.wired.com/story/does-it-matter-if-china-beats-the-us-to-build-a-5g-network/>.

¹⁶ "Why Companies and Countries Are Battling for Ascendancy in 5G," *the New York Times*, 3/6/18, <https://www.nytimes.com/2018/03/06/technology/companies-countries-battling-5g.html>.

¹⁷ "How America's 4G Leadership Propelled the US Economy," Recon Analytics, 4/18, https://api.ctia.org/wp-content/uploads/2018/04/Recon-Analytics_How-Americas-4G-Leadership-Propelled-US-Economy_2018.pdf.

Will 5G remake the world or just make it a little faster?

development of networks.¹⁸

Government policies could accelerate the development of 5G. For example, carriers would likely welcome government assistance to increase the availability of spectrum, defray infrastructure costs, and clear the path for carriers to deploy an estimated 70 million small cells globally by 2025.¹⁹ Spectrum auctions have already been held in South Korea²⁰ and are planned to take place in the United States later in 2018.²¹ Some carriers in other countries are concerned the slower

pace of spectrum auctions, and how they are held, may put them at a disadvantage.²²

Will all these devices and networks be compatible?

While standards for 5G networks and devices are still evolving, important progress is being made. In June 2018, the Third Generation Partnership Project, an international wireless organization, approved specifications for “stand-alone” 5G.²³ These standards will enable development of end-to-end 5G architecture that operates

independently of 4G. While there is more work to be done, this is a significant milestone that will help accelerate 5G deployments.

5G is an evolving technology—really, a set of technologies. In the next year or two, standards will likely be solidified, networks will come online, and billions of devices will connect through them. Whether this evolution will create revolutionary change is unclear. What is clear is that carriers have high hopes and are placing big bets.

¹⁸ For example, Australia’s government is debating whether to hire Chinese equipment manufacturers to build the country’s 5G network based, at least in part, on national security considerations. See: <https://www.businessinsider.com.au/national-security-issues-flagged-with-huawei-for-australian-5g-network-2018-6>.

¹⁹ Millions of small cells will be required to “densify” 5G networks. <https://www.smallcellforum.org/press-releases/market-status-apac-north-america-lead-network-densification-2021/> But some municipalities are unhappy about how many cells will be required, and about the lack of autonomy to decide where they are located and how they will look. <http://www.craigslist.com/article/20180520/news/162291/cities-carriers-strike-compromise-over-5g-technology> In the United States, the FCC is working to streamline regulations so small cells can be deployed faster. See: <http://www.telecompetitor.com/fcc-adopts-new-5g-rules/>.

²⁰ See: <https://www.cnet.com/news/fcc-sets-date-for-first-5g-spectrum-auction/>.

²¹ See: <https://www.cnet.com/news/fcc-sets-date-for-first-5g-spectrum-auction/>.

²² For example, Canadian carriers would like spectrum auctions to happen sooner than 2021, as the government has planned. <https://www.theglobeandmail.com/business/article-canadian-telecom-companies-awaiting-spectrum-auction-prior-to-5g-2/> In the United Kingdom, wireless providers are asking the government to “modernize” how spectrum auctions are held. <https://www.ispreview.co.uk/index.php/2018/06/wireless-isps-call-on-ofcom-to-fix-broken-uk-spectrum-auctions.html>.

²³ See: <https://5g.co.uk/news/3gpp-signs-off-standalone-5g-standard/4406/>.



This publication contains general information only and Deloitte is not, by means of this publication, rendering accounting, business, financial, investment, legal, tax, or other professional advice or services. This publication is not a substitute for such professional advice or services, nor should it be used as a basis for any decision or action that may affect your business. Before making any decision or taking any action that may affect your business, you should consult a qualified professional advisor.

Deloitte shall not be responsible for any loss sustained by any person who relies on this publication.

About Deloitte

Deloitte refers to one or more of Deloitte Touche Tohmatsu Limited, a UK private company limited by guarantee (“DTTL”), its network of member firms, and their related entities. DTTL and each of its member firms are legally separate and independent entities. DTTL (also referred to as “Deloitte Global”) does not provide services to clients. In the United States, Deloitte refers to one or more of the US member firms of DTTL, their related entities that operate using the “Deloitte” name in the United States, and their respective affiliates. Certain services may not be available to attest clients under the rules and regulations of public accounting. Please see www.deloitte.com/about to learn more about our global network of member firms.